

AT-102

12-Channel ECG Recorder

Service Handbook



SCHILLERAG
Altgasse 68
6341 Baar, Switzerland
Phone: + 41 41 766 42 42
Fax: + 41 41 761 08 80
www.schiller.ch

Article Number 2.540.028
SCHILLERAG 2002



THE ART OF DIAGNOSTICS

AT-102 Service handbook
Article Number 2. 540 028

Release a
November 2002

Associated Documents

- Physicians Guide to the SCHILLER Interpretation and Measurement Program
- AT-102 User Guide

The SCHILLER sales and service centre network is worldwide. For the address of your local distributor, contact your nearest SCHILLER subsidiary. In case of difficulty a complete list of all distributors and subsidiaries is provided on our internet site:

<http://www.schiller.ch>

CE 0123



Intended Use

The AT-102 is a 12-channel ECG device used for the recording, analysis and evaluation of ECG Recordings. Recordings made with the AT-102 can be used as a diagnostic aid for heart function and heart conditions. The AT-102 is designed for indoor use and can be used for all patients of both sexes, all races, and all ages.

Physician's Responsibility

The AT-102 ECG Unit is provided for the exclusive use of qualified physicians or personnel under their direct supervision. The numerical and graphical results and any interpretation derived from a recording must be examined with respect to the patient's overall clinical condition. Patient preparation and the general recorded data quality, which could affect the report data accuracy, must also be taken into account.

It is the responsibility of the physician to make the diagnosis or to obtain expert opinion on the results, and to institute correct treatment if indicated.

**FEDERAL LAW IN THE USA RESTRICTS THIS DEVICE TO SALE BY OR
ON THE ORDER OF A PHYSICIAN**



AT-102 Service Handbook

Contents

Intended Use	iii
Physician`s Responsibility	iii
Terms of Warranty	x
Disposal Instructions and Battery Care	xi
Safety Notices	xii
Operational Precautions	xii
Precautions for Operation with other Devices	xiii
Maintenance Precautions	xiv
Symbols and Conventions Used in this Service handbook	xv
What's in this book	xvi

Section 1 Operating Elements 1.1

Introduction	1.2
Features	1.2
Operating Philosophy Overview	1.3
Initiating Functions or Tasks	1.3
Main Components of the AT-102	1.4
Back Panel	1.5
Power Supply	1.6
Switching On and Off	1.6
Changing a Mains Fuse	1.7
Potential Equalisation	1.7
Keypad	1.8
LCD Screen	1.10



ECG Settings	1.12
Auto Format 1 and 2	1.13
ECG Printout	1.13
Average Cycles	1.14
Rhythm Leads	1.14
Measurements, Markings and Interpretation	1.14
Filters	1.15
Baseline filter	1.15
Myogram filter	1.16
Mains filter	1.16
Baseline Stabiliser (SCHILLER SBS)	1.16
Smoothing Filter (SCHILLER SSF)	1.16
Interpretation	1.17
Leads	1.18
Defining Lead Sequence & Printout	1.18
Stress Settings	1.20
General Settings	1.21
Selecting the ERGO Device	1.21
Blood Pressure Entry	1.21
Selecting the Default Test Protocol	1.22
Defining the Stage Printout Format	1.22
ST Amplitude Lead	1.22
Defining / Editing Exercise Protocols	1.23
Factory programmed Treadmill Protocols	1.24
Bruce	1.24
Factory programmed Bicycle Protocols	1.24
System Settings	1.25
Unit	1.26
User Identification (User ID)	1.26
Date and Time	1.26
Language	1.27
Startup Screen	1.27
Paper Mode	1.27
Communication	1.28
Test and Information	1.29
Obtaining a printout of all current settings	1.30
Communications Test	1.32
Upgrade/ Update Software	1.32
Default Settings	1.33
Unit Defaults Table	1.34



Section 2 Functional Overview 2.1

Introduction	2.2
MK 18 - 1 Main Board	2.4
Power Supply	2.4
Program and ECG Memory	2.4
Thermal Print Head Controller	2.4
Printer Timing	2.5
Paper Mark	2.5
Power On Reset	2.5
Stepper Motor Controller	2.5
ECG Isolated Power Supplies	2.5
ECG Signal	2.6
Noise Damping	2.6
RS-232 Interface	2.6
External Modem	2.6
Top Assembly	2.7
LCD Screen	2.7
Alphanumerical Keyboard	2.7

Section 3 Fault Finding 3.1

Introduction	3.2
General Check Procedures	3.2
Fault Finding Chart	3.3
AT-102 Initial Fault Diagnosis Chart (Sheet 1)	3.3
AT-102 Initial Fault Diagnosis Chart (Sheet 2)	3.4
AT-102 Fault Diagnosis Chart (Sheet A - Power Problems)	3.5
AT-102 Fault Diagnosis Chart (Sheet B - Power Problems)	3.6
AT-102 Fault Diagnosis Chart (Sheet C - General Problems)	3.7
AT-102 Fault Diagnosis Chart (Sheet D - Printer Problems)	3.8
AT-102 Fault Diagnosis Chart (Sheet F - Exercise Mode Problems)	3.9
AT-102 Fault Diagnosis Chart (Sheet G - Spirometry Problems)	3.10
AT-102 Fault Diagnosis Chart (Sheet H - Communication (RS) Problems)	3.11



Functional Check	3.12
Thermal Printer Check	3.13
Print Head Alignment and Print Head Tension	3.14
Thermal Printer Fault Diagnosis	3.14
RS-232 Interface (and Spiro Check)	3.15

Section 4 Module Removal and Replacement .. 4.1

Introduction	4.3
Safety Notices	4.4
Physical Overview	4.5
Exploded View Lower Casing	4.6
Exploded View Upper Casing	4.7
Prerequisites, Test Equipment, Tools, and Accessories	4.8
General Prerequisites	4.8
Part Numbers	4.8
Opening and Closing the Case	4.9
Top Assembly Removal	4.9
Top Assembly Replacement	4.11
Main Board MK 18 - 1	4.12
Parts	4.12
Board Removal	4.12
Board Replacement	4.14
Printer Tray and Thermal printer	4.15
Thermal Printer Removal	4.15
Thermal Printer Replacement	4.15
Battery Pack	4.16
Battery Pack Removal	4.16
Checks and Tests After Battery Replacement	4.16
Keyboard	4.17
LCD screen board	4.18
LCD board Removal	4.18



Section 5 Adjustments, System Upgrades and Software Updates 5.1

Introduction	5.3
Safety Notices and Conditions	5.4
Conditions	5.4
Test Equipment	5.5
Proprietary Test Equipment/Tools	5.5
Main Board MK 14-10 Adjustment Locations	5.6
Component Location MK18-1 (Component Side).....	5.6
Battery Charge Voltage	5.7
Precautions and Requirements.....	5.7
Tools and Equipment	5.7
Procedure.....	5.7
Paper Mark Detector Check	5.8
Tools, Equipment and Material	5.8
Procedure.....	5.8
ECG Amplifier +2V, -2V and PWM Ramp Time Adjustment	5.10
Tools, Equipment and Material	5.10
Procedure.....	5.10
Service Screen.....	5.12
Upgrading the Unit / Updating the Software	5.14
Installing New Software Options (Upgrade)	5.14
Updating the System Software	5.16

Section 6 Spare Parts 6.1

Ordering Information	6.2
Spare Parts	6.3



Section 7 Technical Data 7.1

Technical Data 7.3
 System: 7.3
 Safety Standards: 7.4
 Technical Data for ECG: 7.4
 Technical Data for Spirometry (Option): 7.5
 Standard 7.7
 Configurations 7.7

Annex A Glossary A.1

Introduction A.2
 Acronyms A.3

Annex B AT-102 Circuit Diagrams and Engineering Drawings B.1

Index

Terms of Warranty

The CardioLaptop® AT-102 is warranted against defects in material and manufacture for the duration of one year (as from date of purchase). Excluded from this guarantee is damage caused by an accident or as a result of improper handling. The warranty entitles free replacement of the defective part. Any liability for subsequent damage is excluded. The warranty is void if unauthorized or unqualified persons attempt to make repairs.

In case of a defect, send the apparatus to your dealer or directly to the manufacturer. The manufacturer can only be held responsible for the safety, reliability, and performance of the apparatus if:

- assembly operations, extensions, readjustments, modifications, or repairs are carried out by persons authorized by him, and
- the SCHILLER AT-102 and approved attached equipment is used in accordance with the manufacturers instructions.

THERE ARE NO EXPRESS OR IMPLIED WARRANTIES WHICH EXTEND BEYOND THE WARRANTIES HEREINABOVE SET FORTH. SCHILLER MAKES NO WARRANTY OF MERCHANTABILITY OR FITNESS FOR A PARTICULAR PURPOSE WITH RESPECT TO THE PRODUCT OR PARTS THEREOF.

This equipment has been tested and found to comply with the limits for a class A digital device, pursuant to both Part 15 of the FCC (Federal Communications Commission) Rules and the radio interference regulations of the Canadian Department of Communications. These limits are designed to provide reasonable protection against harmful interference when the equipment is operated in a commercial environment. This equipment generates, uses and can radiate radio frequency energy and, if not installed and used in accordance with this instruction manual, may cause harmful interference to radio communications. Operation of this equipment in a residential area is likely to cause harmful interference in which case the user will be required to correct the interference at his own expense.



Disposal Instructions and Battery Care



Do not dispose of battery, boards, or components by fire or incinerator - Danger of Explosion

Do not open the battery casing - Danger of acid burn

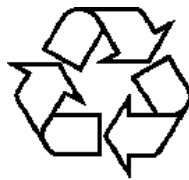

Only dispose of the battery, boards, or components in official recycling centres or municipally approved areas. Alternatively, used batteries and components can be returned to SCHILLER AG for disposal.

Units no longer required can be returned to SCHILLER AG for disposal. Alternatively dispose of the unit in municipally approved recycling centres.



Safety Notices

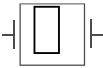

Operational Precautions

- Before using the unit, ensure that an introduction regarding the unit functions and the safety precautions has been provided by a product representative.
- The guidelines for patient electrode placement are provided as an overview only. They are not a substitute for medical expertise.
- IEC 601-1-1 states that the patient must remain at least 1.5 metres clear of the AT-102. When this is not possible an isolation transformer must be installed.
- It must be ensured that neither the patient nor the electrodes (including the neutral electrode) come into contact with other persons or conducting objects (even if these are earthed).
-  This unit is CF classified and defibrillation protected when the original patient cable is used. However, as a safety precaution when possible, remove electrodes before defibrillation.
- Do not touch the unit casing during defibrillation.
- If the patient cable should become defective after defibrillation, lead-off is displayed and an acoustic alarm given.
- Do not operate the unit if the earth connection is suspect or if the mains lead is damaged or suspected of being damaged.
- This product is not designed for sterile use.
- This product is not designed for outdoor use.
- Do not use this unit in areas where there is any danger of explosion or in the presence of flammable gases such as anaesthetic agents.
- Do not operate the unit if the earth connection is suspect or if the mains lead is damaged or suspected of being damaged.
- There is no danger when using the ECG unit for a patient with a pacemaker fitted.
- The LCD screen assembly is heavy and can cause injury if closed unintentionally. Ensure fingers are kept clear.
- Surface temperature of applied parts must not exceed 41°.
- If the display is damaged, a leakage of fluid may occur. do not inhale the vapour from this fluid and avoid contact with mouth and skin. if contact is made, clean contaminated area immediately with fresh water.



Safety Notices



Precautions for Operation with other Devices

- Use only accessories and other parts recommended or supplied by SCHILLER AG. Use of other than recommended or supplied parts may result in injury, inaccurate information and/or damage to the unit.
- Externally connected units must use the same common earth.
- Externally connected units must use an original SCHILLER interface cable.
- If several units are coupled, there is a danger of summation of leakage currents. When two or more units are coupled together, an isolation transformer must be used in the mains supply.
- The AT-102 complies with EMC regulations for medical products which affords protection against emissions and electrical interference. However, special care must be exercised when the unit is used with high frequency equipment.
- There is no danger when using the ECG unit simultaneously with electrical stimulation equipment. However, the stimulation units should only be used at a sufficient distance from the electrodes. In case of doubt, the patient should be disconnected from the recorder.
- To avoid possible interference from the Ergometer when carrying out an exercise test, it is recommended that both the AT-102 and the Ergometer are connected to the same common ground.



Safety Notices



Maintenance Precautions

- BEFORE CARRYING OUT ANY MAINTENANCE PROCEDURES, SWITCH THE UNIT OFF AND DISCONNECT FROM THE MAINS BY REMOVING THE MAINS PLUG.
- The unit is protected by double pole / neutral fusing for continued protection against the risk of fire. Replace only with the same fuse type and rating.
- Do not use high temperature sterilisation processes (such as autoclaving). Do not use e-beam or gamma radiation sterilisation.
- Do not use solvent or abrasive cleaners on either the unit or cable assemblies.
- Do not, under any circumstances, immerse the unit or cable assemblies in liquid.



Symbols and Conventions Used in this Service handbook

The following words and symbols mark special messages throughout this guide.



General Warning. Text set off in this manner indicates that failure to follow directions could result in bodily harm or loss of life or failure to follow directions could result in damage to equipment or loss of information.



WARNING:

Specific Warning. Text set off in this manner indicates that failure to follow directions could result in bodily harm or loss of life.



CAUTION:

Text set off in this manner indicates that failure to follow directions could result in damage to equipment or loss of information.



NOTE:

Text set off in this manner presents clarifying information, specific instructions, commentary, sidelights, or interesting points of information.



What's in this book

The service philosophy for the AT-102 is fault finding to module level. The purpose of this book is to provide all the information necessary to enable the service engineer to efficiently locate and replace a faulty module. This book assumes no detailed knowledge of the AT-102 but does require that the service engineer is familiar with standard workshop practices, and to have attended an AT-102 service course. The book is divided into the following chapters:

Chapter 1 - Operating Elements

The purpose of this chapter is to provide an easy reference for all the main operator functions and to give a basic introduction to the AT-102. This chapter gives details of the operator controls with the operation and function of each key briefly explained. The information in this chapter provides a background to the operating functions only. Complete operating information is provided in the SCHILLER AT-102 User Guide.

Chapter 2 - Functional Overview

This chapter provides a functional overview of the AT-102. The description is supported by functional block diagrams.

Chapter 3 - Fault Diagnosis

This chapter provides a guide to locate a fault to module level. The diagnostics are presented in a logical sequence of fault finding algorithms and procedures. Illustrations are provided to support the text where needed.

Chapter 4 - Module Removal and Replacement

This chapter gives an overview of the physical construction of the AT-102 with the main physical attributes of the unit briefly described. The physical description is supported by illustrations showing the internal location of all modules. Removal and replacement instructions for all removable modules are also provided in this chapter. Each procedure is autonomous with details of tools, jumper settings, adjustments and settings or special requirements that are required before and after replacement. Functional checks that must be carried out after replacing a module are also provided.



Chapter 5 - Adjustments

This chapter provides all adjustments and settings. Also detailed in this chapter are basic functional test procedures that can be performed to check the functioning of the unit.

Chapter 6 - Spare Parts

This chapter provides the part numbers and reordering information for all replaceable modules. Also included in this chapter are details of any special test equipment or special tools required for adjustment or fault finding procedures.

Chapter 7 - Technical Data

The full technical specification of the AT-102 is given in this chapter.

Annex A - Glossary

This chapter explains all the acronyms and signal titles used in this book and in the AT-102 circuit diagrams.

Annex B - Circuit Diagrams & Board layouts

The circuit diagrams and component layouts are provided for all boards. These details are provided for information only.





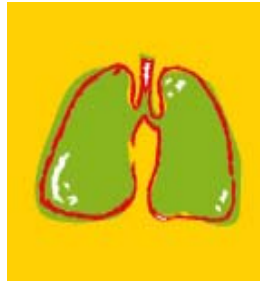

Section 1

Operating Elements

This section contains an introduction to the AT-102 and an overview of all external connections. It also gives an overview of the operating philosophy of the AT-102 and an introduction to the basic functions of the unit. An overview of the system settings are given in this section - for full operating details and system setup see the AT-102 User Guide.

Introduction

The SCHILLER AT-102 is a 12-channel ECG unit designed to record, display, and analyse resting ECGs (exercise ECGs can also be recorded). The unit has been extensively researched to give an ergonomic, clear interface that's easy to use without compromising functionality. The AT-102 has the following features:

Features

- Alphanumeric keypad and dedicated soft key interface for easy, user friendly operation.
- Storage and transmission facilities for recordings.
- Exercise ECG with interface for control of digital ergometers and treadmills. (Option)
- Integral full size thermal quality printer with various user defined print format options. External laser or deskjet printer (Option).
- ECG Interpretation including measurements and average cycles with automatic and manual printout of the recording. (Option)
- Spirometry (Option)

Introduction

Operating Philosophy Overview

There are broadly four types of data display as follows

Data Acquisition and ECG Recording Screen

In this screen the real-time ECG is displayed. From this screen a continuous printout can be initiated and/or an auto recording can be made. In auto mode 10 seconds of ECG data is analysed and averaged and the results given on a printout. The format and data of an auto mode printout is independent of the screen display.

An auto mode recording can also be stored in the memory for later print or transmission.

Memory Screen

In this screen stored recordings can be accessed.

Patient Data Screen

Patient data entry via the keypad.

Data Entry and Setup

In these screens all system settings, resting and exercise ECG settings, and spiro settings are made.

Initiating Functions or Tasks

Most functions and tasks are initiated by the 5 softkeys situated immediately below the LCD. The function of the softkeys varies according to the screen displayed and is displayed on the LCD immediately above the key itself.

During data acquisition, further dedicated function keys are provided to make an auto mode recording (START) and to stop a manual printout (STOP). The top line of the alphanumeric keypad, additionally enables direct settings of lead group, trace speed and sensitivity, filter on/off and other functions, for both the real-time display and (manual) printout.

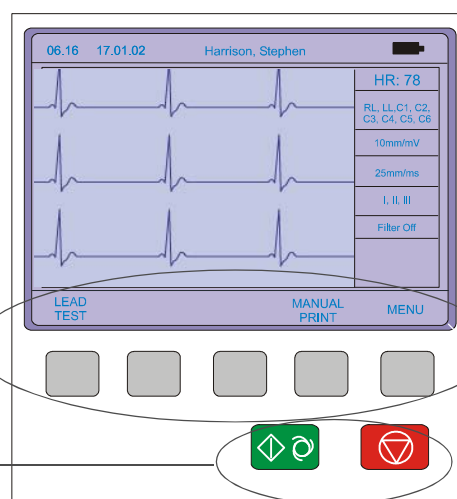

Introduction

Main Components of the AT-102

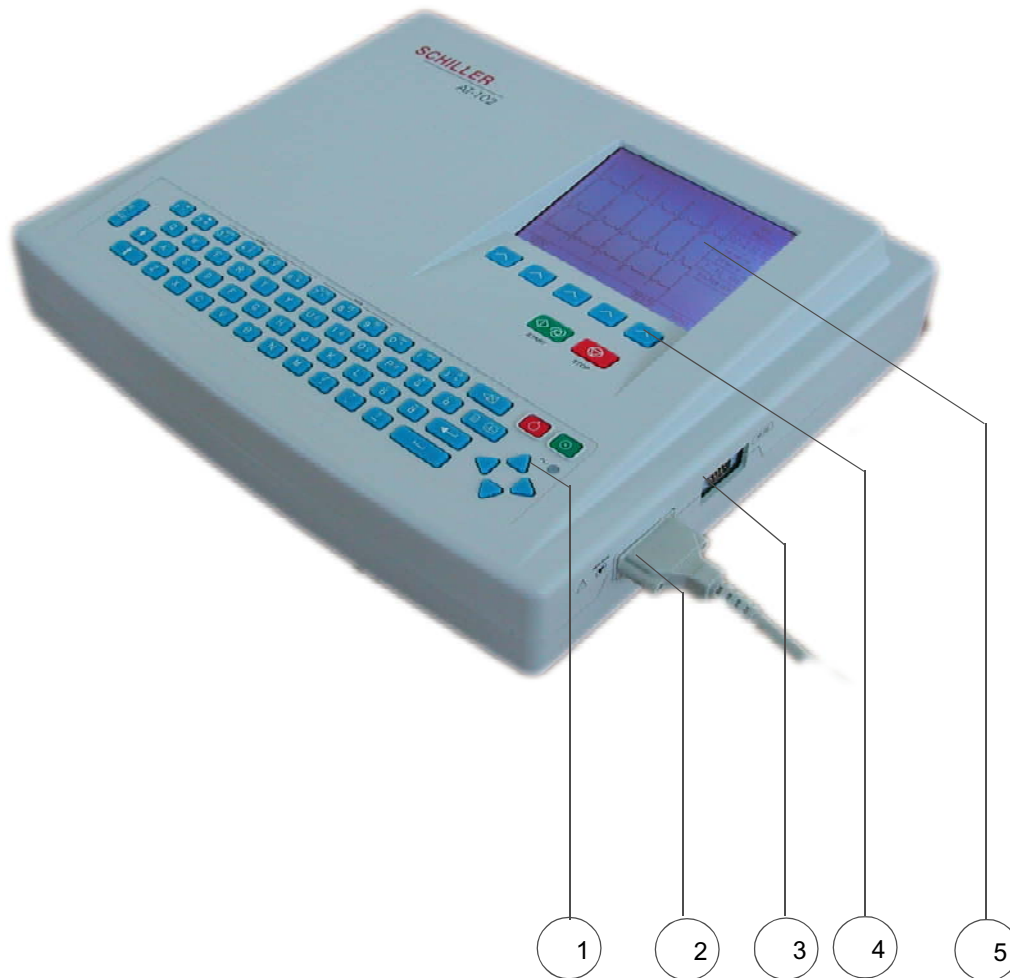

1. Keypad and dedicated function keys
2. Patient cable connector
3. RS-232 for any of the following:
 - connection of an ergo device
 - connection of a spiro sensor
 - connection of a modem or a PC for export of stored recordings
4. Softkey control
5. LCD Display.

Introduction

Back Panel

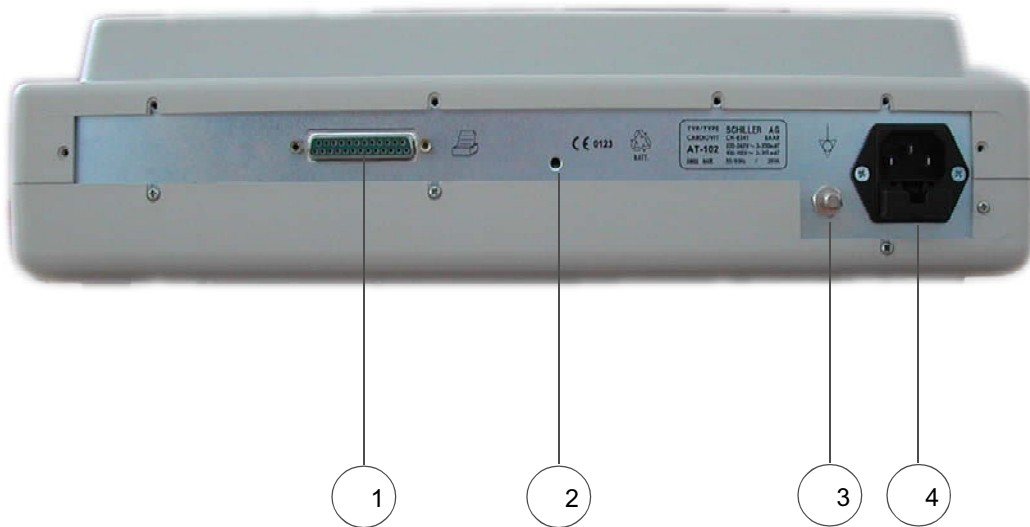

1. LPT connector for the connection of an external printer
2. Master Reset
3. Potential equalisation stud
4. Mains connector (with fuse below)

**CAUTION:**

All externally connected hardware must be approved by SCHILLER. Connection of any hardware not approved by SCHILLER is at the owner's risk. The unit guarantee may also be invalid.

Introduction

Power Supply

The mains connection is on the rear of the unit.

The power supply voltage is set by the factory for 100-115V (nom. 110V) or 220-240V (nom. 230V) working. The setting is indicated by the indented metal strip on the fuse panel. Contact your dealer if the voltage needs to be changed.

Switching On and Off

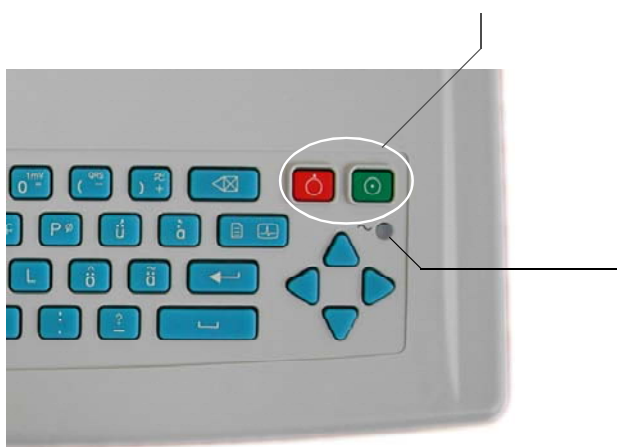

The AT-102 is switched on with the green ON key and off with the red OFF key. These keys are situated on the top right of the keypad.

The mains indicator lamp on the keypad is always lit when the unit is connected to the mains supply.

The unit can either be operated from the mains supply or from the built-in rechargeable battery. The power source is indicated on the top line of

the LCD. When mains is connected a mains symbol is displayed. When the unit is running on battery power a battery symbol is displayed

The internal battery provides power for up to 3 hours. The Battery indicator blinks when the battery capacity is limited.

To recharge the battery, connect the apparatus to the mains supply by means of the supplied power cable. A totally discharged battery requires less than 15 hours to be fully recharged (60% in less than 3 hours, 90% in less than 7 hours). The unit can remain connected to the mains supply without damage to either the battery or the unit.

Power Indicator symbol

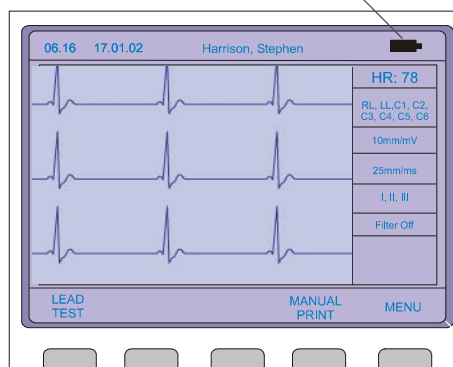

NOTE

When working from battery power, the unit is automatically switched off after 5 minutes (30 seconds if battery capacity is limited) if no key is pressed.



Introduction

Changing a Mains Fuse



CAUTION

If it is necessary to change a fuse, always replace with the correct rating i.e. 2x200mAT for 230V, or 2x315mAT for 110V .

To change a fuse press the retaining lug in the middle of the fuse panel (situated below the mains connector on the back panel). Remove the fuse panel and replace the fuse(s). Click the fuse panel back in position.

Potential Equalisation



The potential equalisation stud at the rear of the unit can be used to equalise the ground potential of the AT-102 to that of all mains powered equipment in the vicinity. Use the hospital or building common ground.



CAUTION:

To avoid possible interference from the Ergometer when carrying out an exercise test, it is recommended that both the AT-102 and the Ergometer are connected to the same common ground.

To prevent the possibility of leakage current when an external printer is connected, always ensure that the mains lead, or the potential equalisation (next to the mains connector), is attached to the AT-102

A yellow/green ground cable is supplied as an option (Article number 2. 310 005).

Introduction

Keypad

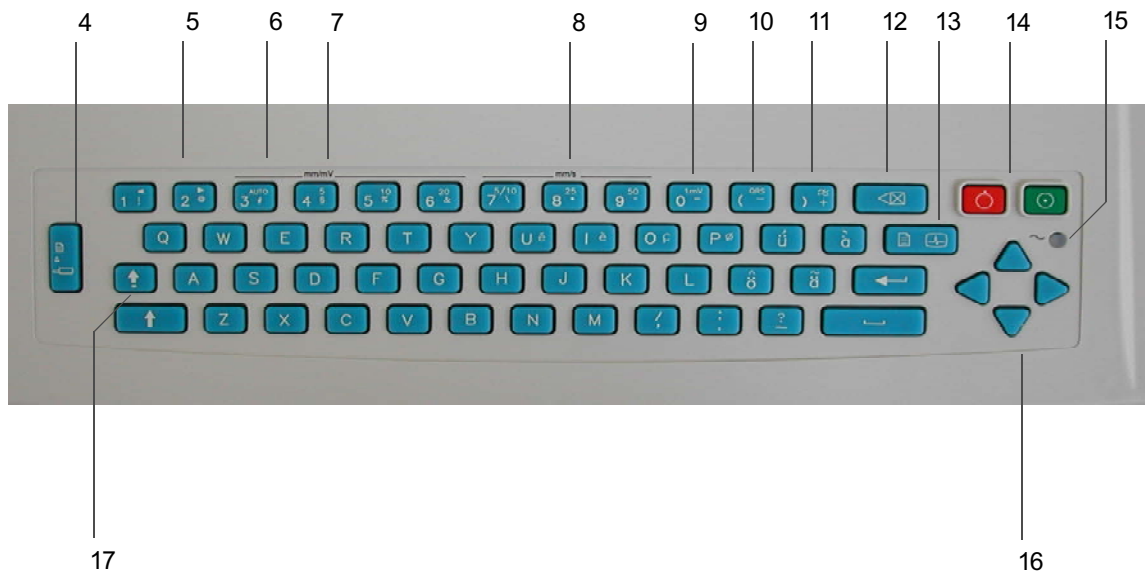
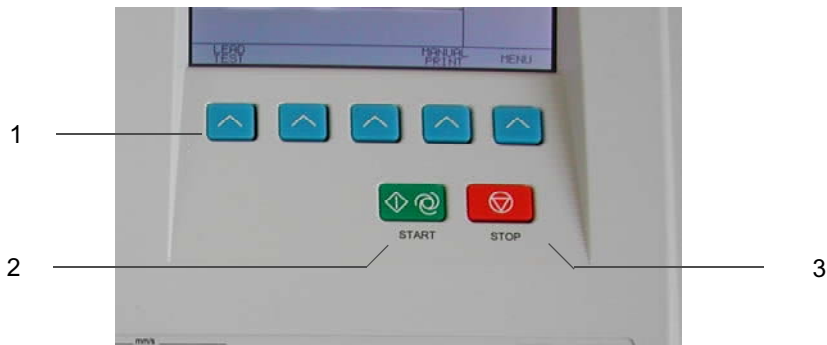

Introduction

1. Softkeys - the function of these keys changes depending on the screen displayed. The function of these keys is shown on the screen above the keys. If nothing is written above a softkey, it has no function for the current screen.
2. Auto Mode recording (in Auto mode 1).
Press the Function key (17) followed by the AUTO key (2) for auto mode 2.
3. STOP printout / confirm (new) setting
4. Open / Close paper tray (to replace thermal printing paper)
5. The top figures on the number keys `1` and `2` (designated < and >), change the lead group displayed on the screen, forward and backward resp.
6. Auto sensitivity key - automatically sets the ECG printout sensitivity (in AUTO mode only) to the best setting for the signal strength (5mm/mV or 10mm/mV)
7. The top figures on the number keys designated 5, 10, and 20 set the sensitivity of the ECG both on the screen and on the (manual) printout. The sensitivity is 5, 10 or 20 mm / mV.
8. The top figures on the number keys designated 5/10, 25, and 50 set the speed of the ECG both on the screen and on the (manual) printout. The speed on the screen can only be set to 25 or 50 mm/s. The speed of the manual printout can be 5, 10, 25 or 50 mm/s. The 5 and 10 mm/s settings are both on the same key which toggles the two speeds.
9. Inserts a 1mV reference marker on the screen and printout. Recentres the trace.
10. Toggles the QRS beeper ON/ OFF
11. Myogram filter ON / OFF. The cutoff frequency can be user defined in `Setup`.
12. Delete last typed character.
13. Patient data key. Press this key to enter a new patient or modify the data for the current one.



NOTE:

The patient data screen, or the ECG screen is the first screen displayed on initial switch on. This is set for user preference in the system settings (See following).

14. ON / OFF Keys
15. Mains Indicator - lit when mains connected.
16. Press the function key (17) and the UP/DOWN arrows to adjust screen contrast.
When entering patient data use the LEFT/RIGHT arrow keys to move the cursor in the data field. Use the UP/DOWN arrow keys to go up/down to the next data entry
17. Function Key (Fn). When pressed before another key, initiates the second function of that key.
For example, second letters on the keypad (è, é, ç, ø @ etc.), are entered by holding the function key before pressing the letter key.



Introduction

LCD Screen

The display will vary according to the current task being carried out. In all screens however, the top and bottom lines always display the same information: the top line displays system information (time, patient, power source etc.), and the bottom line always gives the softkey options.

The following is an example of a typical resting ECG screen.

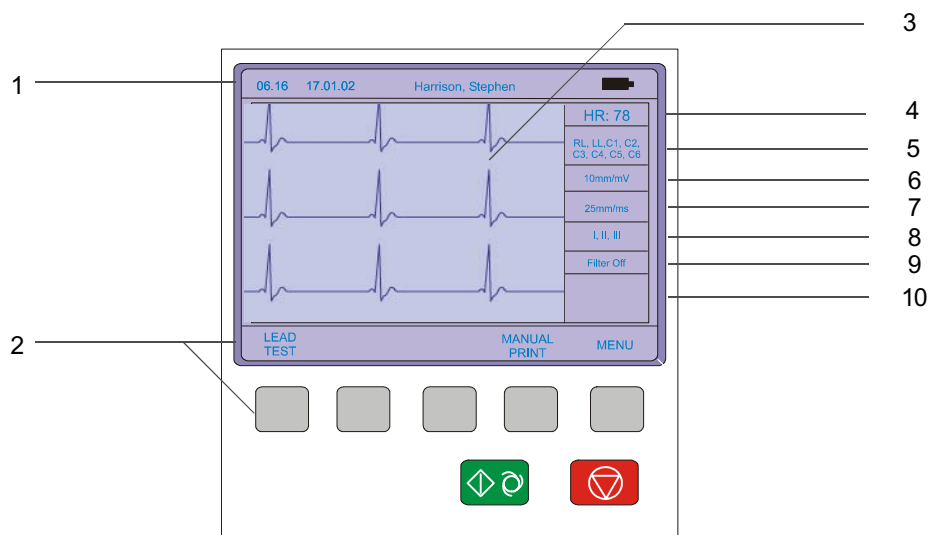

Items 1, 2 and 3 are in the same position for all screens.

1. **Top line - time, date, patient name, and current power source - mains (⎓), or battery (🔋). When battery capacity is limited the battery symbol flashes.**
2. **Softkey designation. Pressing the key below the text carries out the function indicated. The options available will change according to the screen displayed.**
3. **Data acquisition area or data entry area.**

Introduction

Items 4 to 10 are specific for ECG acquisition only:

4. Current Heart Rate (averaged over 4 beats and refreshed every 2 seconds). The HR is also given on a manual printout. *Note that with an auto mode printout the HR is averaged over the full 10 seconds of the recording.*
5. Electrode connections - when a lead flashes it indicates that the electrode resistance is too high. The electrode(s) must be reapplied.
6. Sensitivity - 5, 10 or 20 mm/mV. Change the sensitivity with the keys 3 (auto), 4, 5 and 6. An `A` in this box indicates that automatic sensitivity is selected (auto mode printout only).
7. Speed - 25 or 50 mm/s. Change the speed with the keys 8 and 9.
8. Lead indication (leads currently displayed on the screen). Change the lead group with the < and > keys on the keypad.
9. Myogram Filter indication - 'Filter ON' or 'Filter OFF'. The filter is applied with the filter key.
Note: the frequency of the filter cutoff is defined in Section 4 Setup.
10. Area for system messages or instructions.

ECG Settings

The AT-102 ECG and system settings are entered by selecting 'setup' from the initial screen:

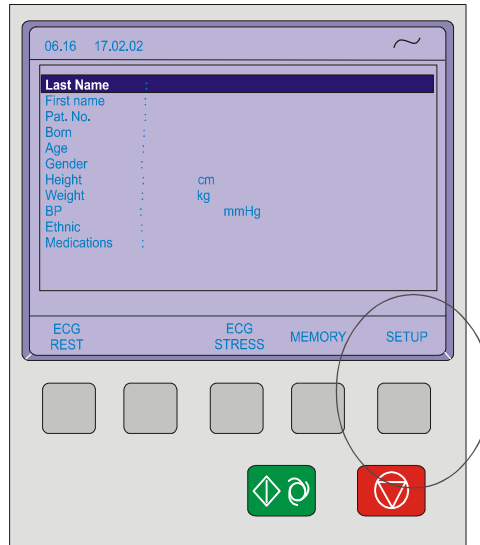

The following pages detail the programmable ECG parameters.



NOTE:

In units where the interpretation option is not installed, interpretation statements, cannot be displayed.

ECG Settings

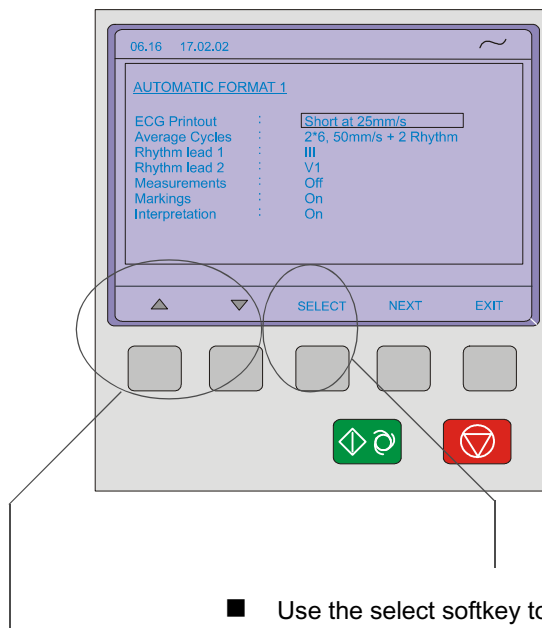
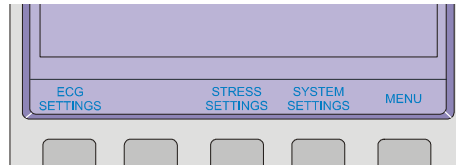

- Use the select softkey to select the different settings
- Use the Up/Down softkeys to highlight the various options.

Auto Format 1 and 2

Two separate Auto formats can be defined for the AT-102. Use the NEXT softkey to confirm setting and to move onto the next screen (Format 2).

ECG Printout

Press the `SELECT` softkey to choose from the following options:

- No Printout** No printout of the ECG given at the end of an auto mode recording (the recording can be stored in the memory and printed at a later time if required).
- 4*3 + 1 Rhythm** Leads are printed in a 4 * 3 format at 25mm/s, with the selected rhythm lead at the bottom of the page at 25mm/s.
- 1*12 at 25mm/s** Leads are printed in a 1 * 12 format at 25mm/s - no rhythm lead printed.

ECG Settings

8*5s + 4*10s	The first 8 leads printed for 5 seconds and the last 4 leads printed for 10 seconds.
Short at 25mm/s	Leads are printed in short form (1 sheet) at 25mm/s.
Long at 25mm/s	Leads are printed in long form (2 sheets) at 25mm/s.
Long at 50mm/s	Leads are printed in long form (2 sheets) at 50mm/s.

Average Cycles

No Printout	No printout of average cycles
4*3, 25mm/s + 2 Rhythm	Leads are averaged over the entire 10 second recording and printed in 4 groups of 3 leads at 25mm/s, with the two selected rhythm leads at the bottom of the page at 25mm/s.
4*3, 50mm/s + 2 Rhythm	Leads are averaged over the entire 10 second recording and printed in 4 groups of 3 at 50mm/s, with the two selected rhythm leads at the bottom of the page at 25mm/s.
2*6, 50mm/s + 2 Rhythm	Leads are averaged over the entire 10 second recording and printed in two groups of six at 50mm/s, with the two selected rhythm leads at the bottom of the page at 25mm/s.

Rhythm Leads

Select the rhythm lead 1 and rhythm lead 2 as described above.

Rhythm Lead 1	Select any lead (I, II, III, aVR, aVI, aVF, V1 to V6)
Rhythm Lead 2	Select any lead (I, II, III, aVR, aVI, aVF, V1 to V6)

Measurements, Markings and Interpretation

Measurements	Select yes or no to print a detailed table of measurement results
Markings	Select yes or no to print reference markings on the ECG average cycle print. A vertical marker shows the beginning and end of P wave and QRS, and the end of the T wave
Interpretation	Select yes or no to print interpretation statement

Full details of the interpretation option are given in the SCHILLER ECG Measurement and Interpretation booklet (art. No. 2.510 179).

ECG Settings

Filters

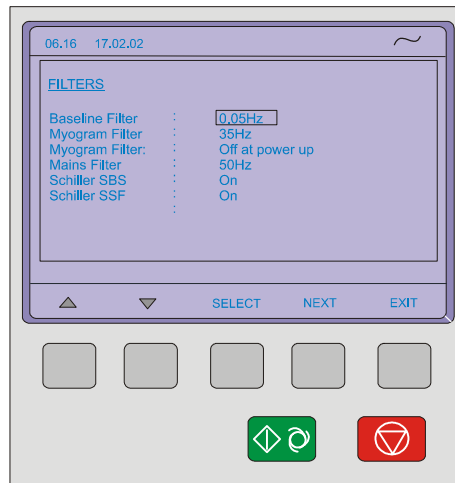

There are five different filters which can be set individually as follows:

Baseline filter

The cutoff frequency of the filter is set on the top line. The cutoff can be 0.05Hz, 0.15Hz or 0.3Hz.



Note:

The set value is the lower limit of the frequency range and is normally set to 0.05 Hz. The settings 0.15 and 0.30 Hz should only be used when absolutely necessary, as the possibility exists that they could affect the original ECG signal, especially the ST segments.

ECG Settings

Myogram filter

The Myogram filter suppresses disturbances caused by strong muscle tremor. The filter is applied by pressing the **FILTER** key (or programmed on as default when the unit is switched on).

When the Myogram filter is on, `FILTER ON` is displayed in the information box.



The cutoff frequency is user defined at 25Hz or 35Hz. When `off at power up` is selected, the Myogram filter is off when the unit is first switched on.

Note: An ECG recorded in auto mode is stored unfiltered. It is therefore possible to print the stored ECG either with or without passing the myogram filter. Filter ON is indicated on the LCD.

Mains filter

The mains filter is an adaptive digital interference filter designed to suppress ac interference without attenuating or distorting the ECG.

Set the mains filter in accordance with the frequency of your local mains supply.

Baseline Stabiliser (SCHILLER SBS)

The baseline stabiliser greatly reduces the baseline fluctuations without affecting the ECG signal. The purpose of the stabiliser is to keep the ECG signals on the baseline of the printout. This filter is only effective in auto mode printout. The Baseline Stabiliser is applied to a recording (on), or not applied to a recording (off).

Smoothing Filter (SCHILLER SSF)

The smoothing filter (SSF: SCHILLER smoothing filter) is a low pass filter to suppress high frequency artefacts between the QRS complexes. When this filter is switched on, `SSF` is shown on the bottom line of the automatic printout.

ECG Settings

Interpretation

The interpretation settings enable the user to determine whether or not certain comments will be added to the interpretation statements on the ECG printout. Furthermore, the patient's age can be assumed (≤ 30 or >30). Low or high can also be set for interpretation sensitivity. Low sensitivity will suppress certain non-specific ECG diagnoses; this may be advisable when carrying out ECGs for screening.

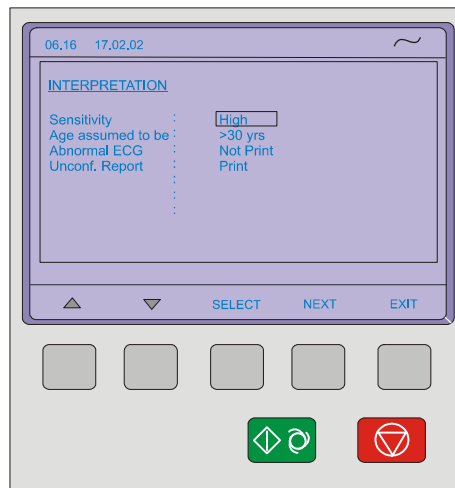

- Sensitivity High or low sensitivity
- Age Assumed to be Greater than 30 years, or 30 years and under.

NOTE:

 The 'Patient age assumed to be..' setting is only applicable when patient data has not been entered. When a patient's date of birth has been entered, this setting is ignored.

- Abnormal ECG `Normal` / `Abnormal` is printed or not printed
- Unconfirmed Report `Unconfirmed Report` is printed or not printed

ECG Settings

Leads

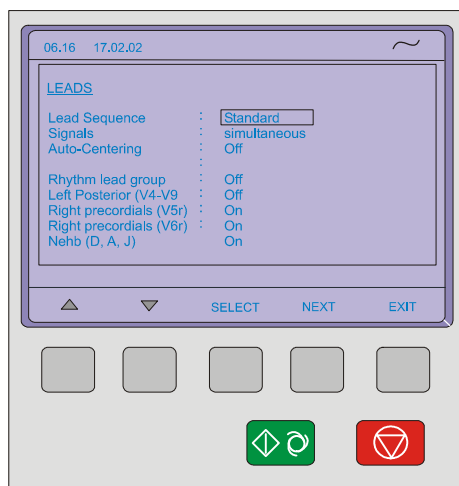

Defining Lead Sequence & Printout

The required settings can be selected as follows:

Lead Sequence Select between:

Standard lead sequence or

Cabrera lead sequence

Signals Select between:

Simultaneous - all ECG leads are printed in the same time segment (in automatic mode only), or

Sequential - each group is a contiguous time segment of approximately 2.5 or 5 seconds (in automatic mode only).

Auto-Centering Select between:

On - all ECG traces are centred dynamically for optimal use of paper width, or

Off - ECG traces are set to a fixed baseline position and may possibly overlap.

ECG Settings

The lead group settings allow extra leads to be displayed on the screen when set to `on`. The following lead groups can be displayed:

Rhythm Lead Group	II, avF, III /	V2, V4, V5
Left Posterior (V4-V9)	V4, V5, V6 /	V7, V8, V9
Right Precordials (V5r)	V1, V2, V3 /	V3r, V4r, V5r
Right Precordials (V6r)	V1, V2, V3r /	V4r, V5r, V6r
Nehb (D, A, J)	D, A, J	(only three leads)

The above leads can also be printed when displayed (only in manual mode)

The lead groups are changed both on the screen and on the manual printout with the lead next/previous keys:

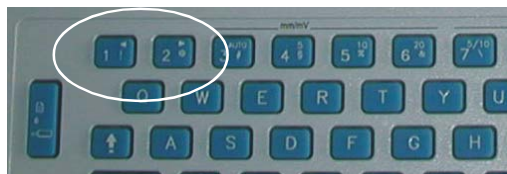

Stress Settings

The AT-102 Stress ECG settings are entered by selecting 'Setup' and 'Stress Settings' from the initial screen:

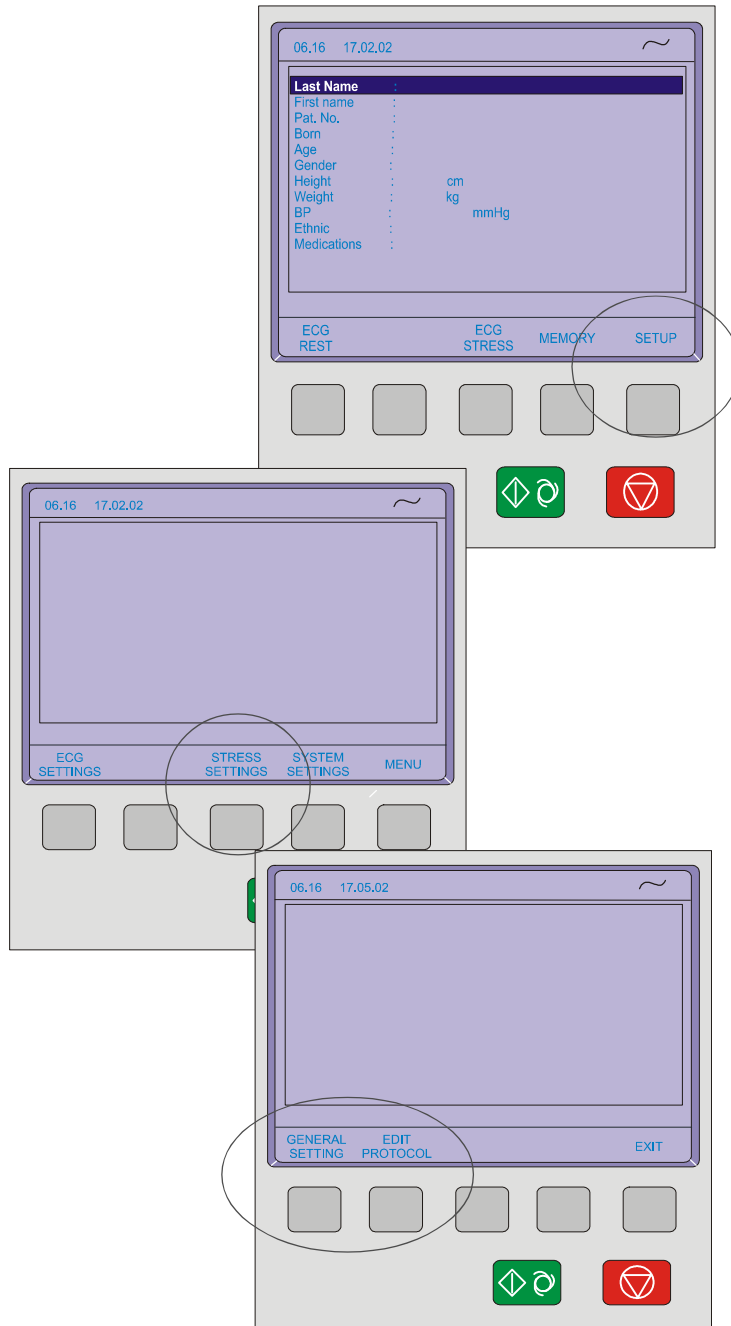

The following pages detail the stress settings for the AT-102.

Stress Settings

General Settings

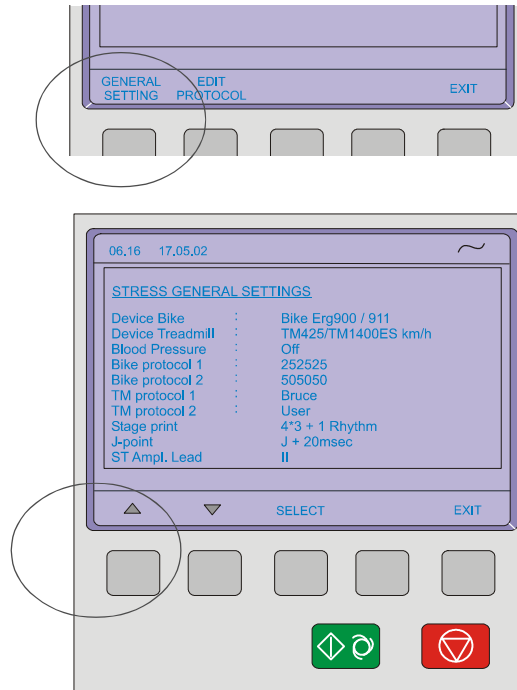

Selecting the ERGO Device

Ergo devices available for use with the AT-102 are as follows:

Bikes:

- The Ergoline digitally controlled exercise bicycle 900 / 911
- SECA CT100 mod.545

Treadmills:

- The Ergoline digitally controlled treadmill TM435/TM4000ES
- RAM 770CE
- MTM-1500

Blood Pressure Entry

Select between Off, Auto and Manual. When Manual is selected the BP screen (for entry of blood pressure), is displayed 55 seconds before the end the stage. When the stages are less than one minute long, or a stage is held, then the BP screen is displayed every 2 minutes.

The AUTO function is not available at the time of print.

Stress Settings

Selecting the Default Test Protocol

Two protocols for a bike and two for a treadmill are available for selection when starting a stress test - the two protocols displayed when starting a stress test are defined here.

The user defined protocols (one for a treadmill and one for a bike) are defined by the user (see following page).

Defining the Stage Printout Format

A stage printout is given at the end of every stage. When the stages are less than 2 minutes long, or a stage is held, then a printout is given every 2 minutes.

The waveforms are averaged to give 4 x 3 plus 1 rhythm lead, or 6 x 2. The rhythm lead printed is the ST lead defined below.

ST Amplitude Lead

Define the lead that is used for ST measurement. This lead is also printed as the rhythm lead if set in the stage printout.

Stress Settings

Defining / Editing Exercise Protocols

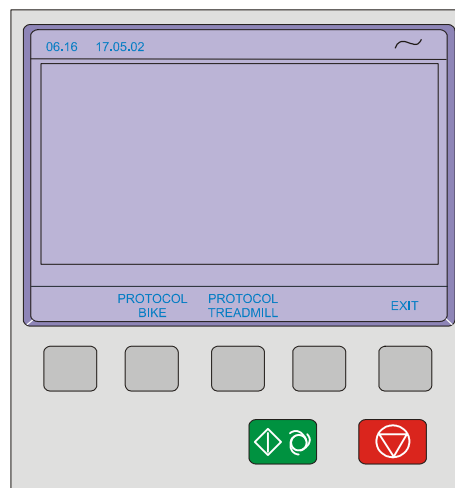
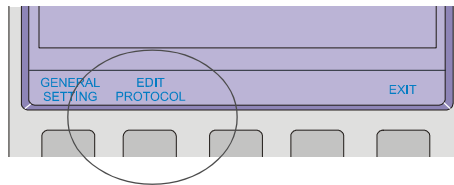

For a bicycle the following can be defined:

- Protocol Name - The name defined here appears in the general stress settings (when selecting the two default bike protocol (see previous page)
- Base Load - The load in Watts, applied during the warm-up period
- Step load - The load increase at every step
- Recovery Load - The load applied during the recovery phase
- Step Interval - The duration of each step

For a treadmill Protocol, the following can be set:

- Protocol Name - As above
- Step Interval - The duration of each step
- Speed - The individual treadmill speed of each step
- Elevation - The individual treadmill elevation of each step

Stress Settings

Factory programmed Treadmill Protocols

One factory programmed Treadmill protocols is available as follows:

Bruce

Stage	Duration	Speed	Elevation
1	3 min	2.7km/h (1.7mph)	10%
2	3 min	4.0km/h (2.5mph)	12%
3	3 min	5.4km/h (3.4mph)	14%
4	3 min	6.7km/h (4.2mph)	16%
5	3 min	8.0km/h (5.0mph)	18%
6	3 min	8.8km/h (5.5mph)	20%
7	3 min	9.6km/h (6.0mph)	22%

Factory programmed Bicycle Protocols

One factory programmed Bicycle protocols is available 252525. This gives a base load (warmup) of 25W (50W), with a step load for both protocols of 25W and a recovery load of 25W.

System Settings

The AT-102 system settings are entered by selecting 'setup' and 'system settings' from the initial screen:

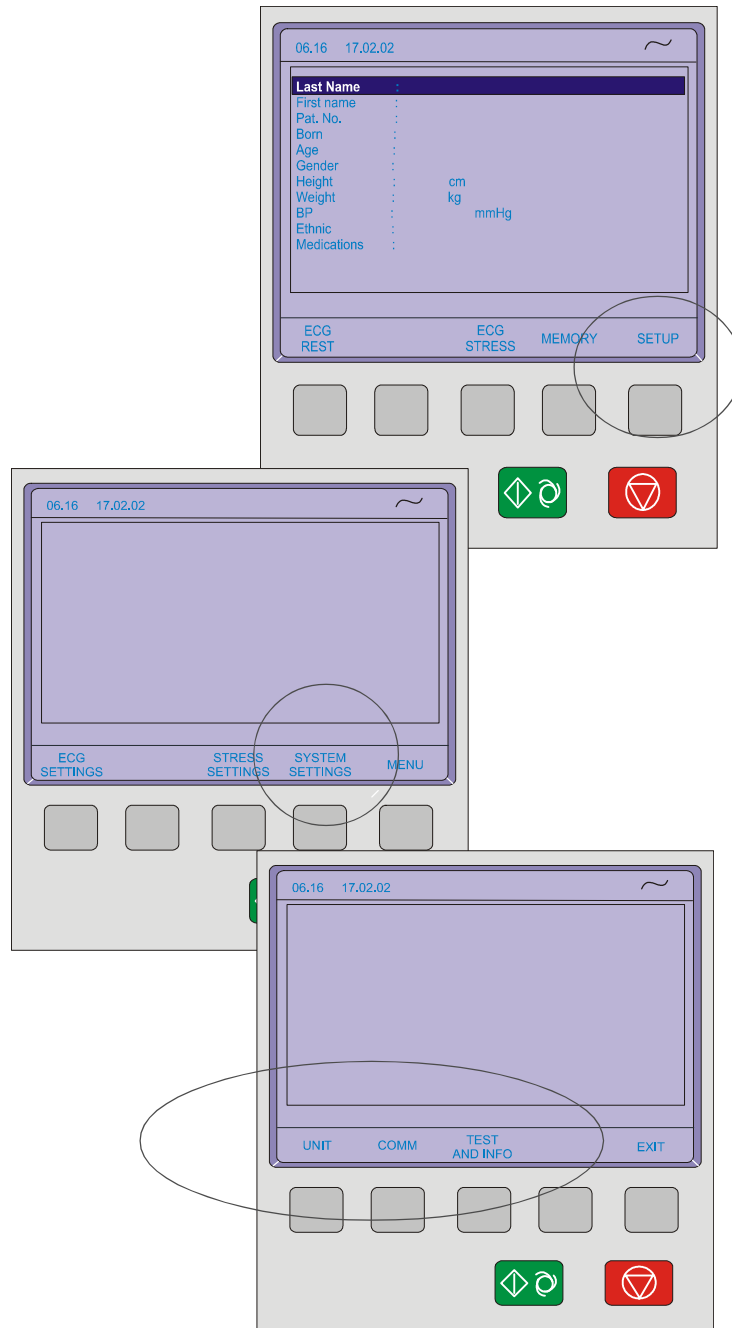

The following pages detail system settings for the AT-102.

System Settings

Unit

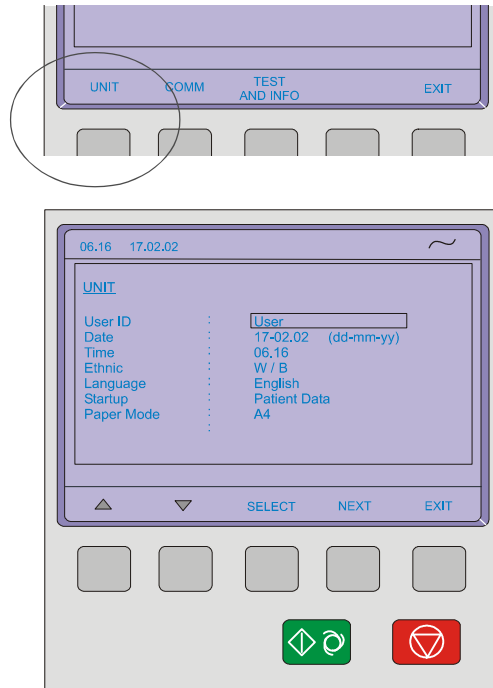

User Identification (User ID)

The user identification is printed on all recordings. The user ID can be the department, doctor or hospital etc. Select User ID and a blinking cursor is present - enter up to 30 characters via the keypad.

Note: If the unit is reset to the default settings (see following), the user identification must be re-entered.

Date and Time

Enter the date in the format day.month.year. Enter the time using the standard 24 hr notation. When set, the ENTER key must be pressed to confirm.

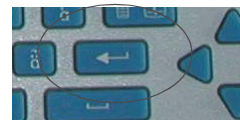

System Settings

Language

Several languages are already programmed into the unit. Select the language for the screen display and for the printout. The language will also set the units used by the system.

The difference between American and English is as follows:

American	Standard English
measurements in inches	measurements in centimetres
temperature in Fahrenheit	temperature in degrees centigrade.
Mains filter setting - 60Hz	mains filter setting - 50Hz
date order mm-dd-yy	date order dd-mm-yy

Additionally, when American is set, further race settings are given and Spiro diagnosis is based on ITS recommendations - see Spirometry handbook.

The default language is (Standard (International)) English.

Startup Screen

Here you can specify the first screen to be displayed when the unit is switched on. Select between patient data screen (for entry of new patient) or data acquisition screen (ECG).

Paper Mode

The internal printer can print on A4 or letter size paper. Set according to the paper used.

System Settings

Communication

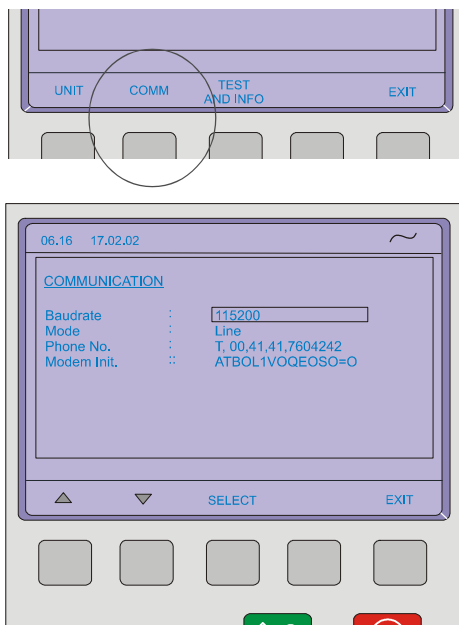

- Baudrate** Select a Baud rate between 115200 and 9600 Baud, according to the modem/computer used. Most computers can connect at 115200 Baud and the standard modem speed is 57600 Baud. If problems are experienced during transmission reduce the Baud rate.
- Mode** Select between line (computer connected directly to the RS-232 interface), or modem (for transmission over the phone network)
- Phone No.** Enter the telephone number preceded by `T` or `P` (tone or pulse).

A comma `,` gives a one second pause in dialling - this may be necessary for example, if an outside line is required.
- Modem Init.** Enter the modem initialisation codes. Full details will be found in the user guide for your modem. However, the modem initialisation must contain at the minimum, the following commands with the prefix `AT`.

 - `Q0` - modem sends response
 - `V0` - numerical response codes
 - `E0` - no command echo

The standard modem initialisation code is: ATB0L1V0Q0E0S0=0

If in doubt about any of these settings, please contact your phone company and/or modem supplier.



System Settings

Test and Information

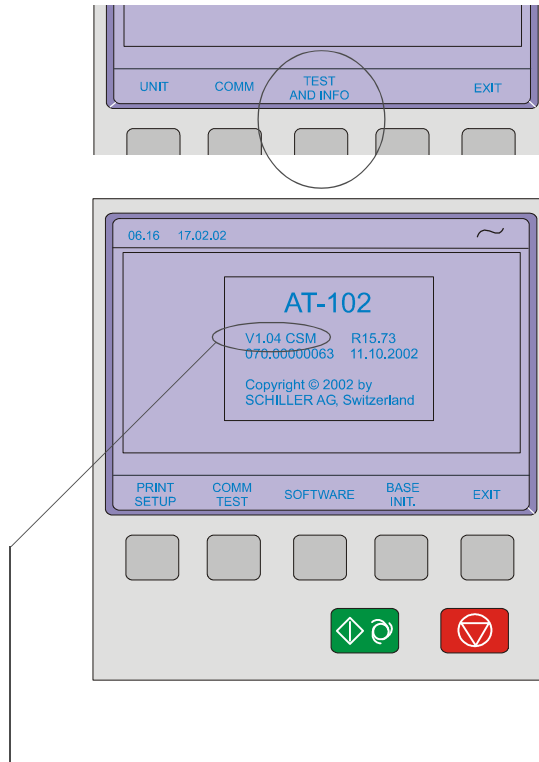

A code of the options installed is given after the software version. These are as follows:

- C = Interpretation
- S = Stress
- M = Memory (Standard)

System Settings

Obtaining a printout of all current settings

To obtain a printout press the 'PRINT SETUP' softkey

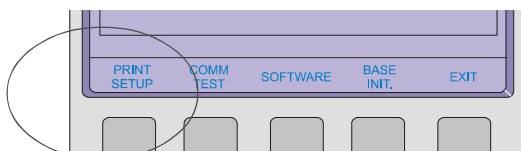

A printout of the defined settings will be produced and gives the following information, depending on the installed software:

Unit designation	Software version, Software options installed (C = Interpretation, M = Memory (standard), S = Stress) and Serial number of the unit	
ECG Format (1 and 2)	Speed	Default speed setting
	Auto printout	Long (ooo), Short (o) or Suppressed (-)
	MECG	Average cycles as defined in auto ECG recording setup (e.g. 4 * 3 (25 mm/s) + 2)
	Rhythm leads	Leads selected for R1, R2 resp.
	Measurements	Print - Enabled (+) or Suppressed (-)
	Marks	Print - Enabled (+) or Suppressed (-)
	Interpretation	Print - Enabled (+) or Suppressed (-)
Leads	Sequence	Standard (S) or Cabrera (C)
	Signals	Printout of signals - Sequential or Simultaneous
	Auto Centering	Enabled (+) or Suppressed (-)
	Lead Group	Rhythm, V9, V4r, V6r, DAJ, ON (+) or OFF (-) for each lead group

System Settings

Filter	Baseline Filter	0.05, 0.15 or 0.30 Hz
	Mains Filter	50, 60 Hz or OFF (-)
	Myogram Filter	25 or 35 Hz, ON (+) or OFF (-)
	SSB Filter	Smoothing Filter Enabled (+) or Suppressed (-)
	SSF Filter	Baseline Stabiliser Enabled (+) or Suppressed (-)
Interpretation	Sensitivity	Low (-) or high (+) sensitivity
	A30	Patient age is assumed to be ≤ 30 (-) or >30 (+)
	U	'Unconfirmed report' is written (+) or suppressed (-)
	Abnormal	Normal / Abnormal printed Enabled (+) or Suppressed (-)
Comm	Baud rate	115200, 57600, 38400, 28800, 14400 or 9600. This is followed by parity setting (Y/N), bits and number of stop bits.
	Mode	Line or Modem
Spiro	F=f(v)	Enabled (+) or Suppressed (-)
	Flow =f(V)	Enabled (+) or Suppressed (-)
	Diagn.	Enabled (+) or Suppressed (-)
	PEFD (l/min)	Enabled (+) or Suppressed (-)
	Axis	5, 10 or 20 mm/s
Stress	Bike	900 / 911 or SECA CT100 or none
	Prot	252525 or user
	TM	ETM435/TM4000ES or RAM 770CE or MTM-1500 or none
	Prot	Bruce or user
	BP	Manual, automatic or none
	Stage Print	leads and format
	ST Lead	Defined lead for ST Measurement
	J- Point	J plus 20ms, 40ms, 60ms, or 80ms
Date and Time	System date and time, and user ID (if set)	

System Settings

Communications Test

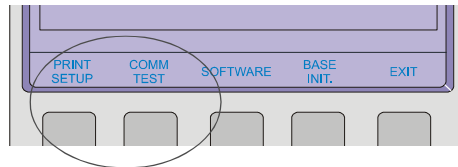

When this is selected, test options are given for the RS-232 communication port. Use this test if the RS-232 port is suspected of malfunction. A special test plug is used to carry out the UART test. Full details if checking the RS-232 port is given in the AT-102 Service Handbook.

Upgrade/ Update Software

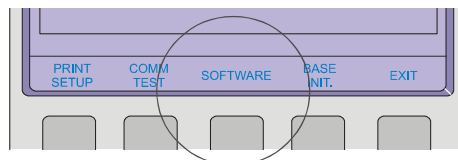

Use the upgrade option to install any available software options (e.g. Exercise). An upgrade code can be obtained from SCHILLER.

Use the Update option to update the current software.



NOTE:

Details of these procedures are given in Section 5 of this handbook.

System Settings

Default Settings

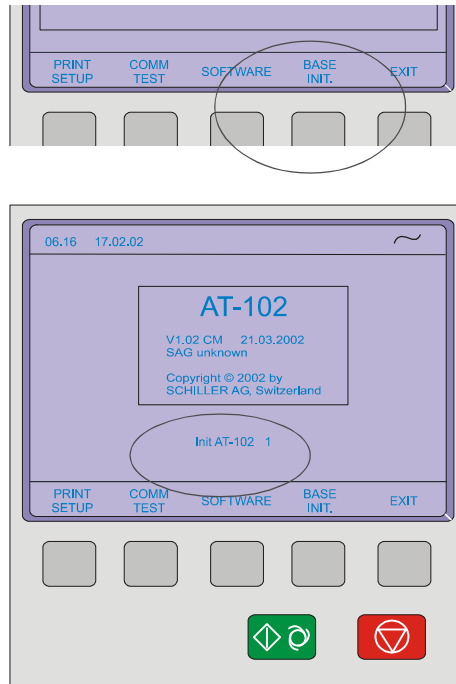

To reset the unit to the base default settings, press the 'BASE INIT' softkey. As the unit resets to the default values a message is briefly displayed on the LCD. The base settings (Defaults) are given on the following page.

System Settings

Unit Defaults Table

Settings	Standard	With Interpretation
Language	As set	As set
Auto Format 1	ECG: 25mm/s, short (o) Rhythm Leads V1	ECG : 25mm/s, short (o) Rhythm Leads V1, II MECG: 2*6 (50mm/s + 1) Measurements: Suppressed (-) Interpretation: Enabled (+) Marks: Enabled (+)
Auto Format 2	ECG: 25mm/s, Long (ooo) Rhythm Leads V1	ECG : 25mm/s, long (ooo) Rhythm Leads V1, II MECG: none Measurements: Suppressed (-) Interpretation: Suppressed (-) Marks: Enabled (+)
Leads	Sequence Standard (S) Rhythm On (+) V9 On (+) V4r Off (-) V5r Off (-) DAJ Off (-) Autom. Centering Enabled (+) Signals Sequential	Sequence Standard (S) Rhythm On (+) V9 On (+) V4r Off (-) V5r Off (-) DAJ Off (-) Autom. Centering Enabled (+) Signals Sequential
Filter	Baseline 0.05Hz Mains Filter 50Hz (60Hz) Myogram 35Hz, OFF	Baseline 0.05Hz Mains Filter 50Hz (60H) Myogram 35Hz, OFF
Memory and Communication	Baud rate 57600 bps Trans. mode: line	Baud rate 57600 bps Trans. mode: line
Interpretation Settings		Suppressed (-) U: Enabled (+) A30: Age assumed to be ≤ 30



System Settings

Settings	Standard	With Interpretation
Spiro	FVC=f(t) on(+) F=f(v) on(+) Diagn.on(+) PEF (l/min)on(+) Axis 10 mm/s	FVC=f(t) on(1) F=f(v) on(+) Diagn.on(+) PEF (l/min)on(+) Axis 10 mm/s
Stress	Bike 900 / 911 Prot 252525 TM ETM435/TM4000ES Prot Bruce BP off Stage Print 4*3 + 1 Rhythm ST Lead V5 J- Point J + 60msec	Bike 900 / 911 Prot 252525 TM ETM435/TM4000ES Prot Bruce BP off Stage Print 4*3 + 1 Rhythm ST Lead V5 J- Point J + 60msec

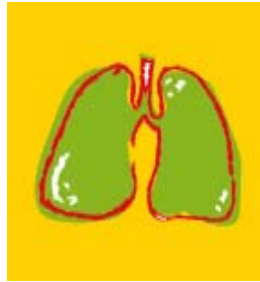

Section 2

Functional Overview

Introduction

This chapter provides a functional overview of the AT-102 electronics. The aim of this overview is to enable the service engineer to identify processing paths in order to help identify possible faulty modules. A functional block diagram supports the text.

Most of the electronics are mounted on a single main board which is housed in the base of the two part AT-102 casing.

The main functional areas of the AT-102 are as follows:

On the Main Board:

- CPU (68332)
- Opto isolated and shielded ECG multiplexer with isolated power supply and patient interface
- Power Supply
- Flash EPROM (electrically erasable) 16 Megabytes

In the top assembly

- Keyboard
- TFT screen

In the base assembly:

- Thermal Printer
- Paper tray drive motor
- Battery

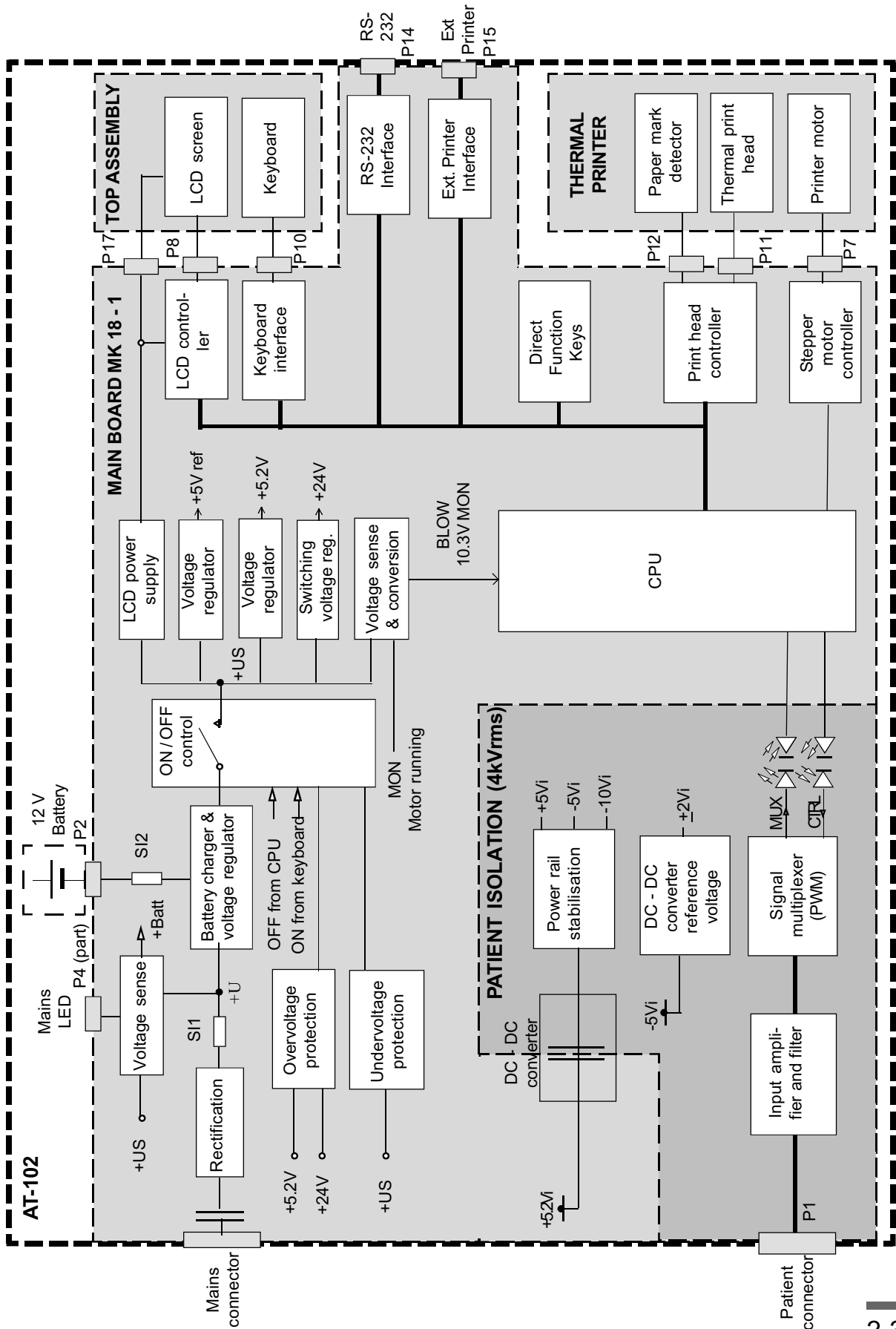

MK 18 - 1 Main Board

Power Supply

The mains supply is full wave rectified to produce an unregulated dc supply of approximately 30 V (+U). This voltage is used by a switched voltage generator to produce +UD (13.5V). +UD charges the battery when mains is connected. When mains is not connected, +UD is the battery voltage.

An ON/OFF control logic switches +UD to three voltage regulators. The unit is switched on directly from the keyboard and then held on from the CPU. Detection of overvoltage on either the 5.2 V or 24 V supplies directly switches the unit off. Similarly when an undervoltage is detected on +US (indicating overcurrent) the unit is directly switched off.

The mains LED is lit directly when mains is connected. The same circuit also monitors the switched dc supply (+US) and activates signal +BATT when the unit is switched on and mains is not connected (i.e. the unit is running on battery power).

A Battery low signal (BLOW) is set to logic 0 when battery voltage (+US) falls to 11.3 V. A circuit compensates for voltage drop when the printer stepper motor is active and the BLOW signal is active only at 10.3 V.

The battery voltage is also monitored directly by the CPU which switches the unit off when the voltage falls below approximately 9.4 V.

Program and ECG Memory

A FLASH EPROM (electrically erasable) contains the unit software (512 kByte) and the stored ECG data. The two memory blocks can be independently erased. It is possible to update the software via the RS-232 serial interface.

The a serial EEPROM stores the unit base settings.

Thermal Print Head Controller

The Thermal Print Head is controlled by a print head controller and a CPU timer circuit. The print head controller serialises the data for the print head and the timer circuit controls how long current is applied to the head, and thus the intensity of the printout.

MK 18 - 1 Main Board

Printer Timing

Strobe generation is controlled by the CPU when one complete pixel line of data is ready to be written. Pulse length of STRB1 and STRB2 (each of which controls half of the pixel array) depends from TPH temperature and so from the pulse width of the TPHT signal.

Paper Mark

The pulsed paper mark signal from the printer is fed to a comparator. A detected papermark sets PMARK at the output of comparator (U44), to logic 0.

Power On Reset

The Power on reset circuit controls the master reset of the CPU. This circuit has two functions as follows:

- To provide a delay on initial switch-on to ensure that the power supply is fully stabilized and give the 200ms reset time required by the 68332 processor.
- To disable the unit if the +5V rail drops below +4.75V.

Stepper Motor Controller

The printer stepper motor controller sets the speed of the printer motor with a clock frequency dictated by the master CPU.

The purpose of the stepper motor controller circuit is to ensure that the motor speed requested by the microprocessor is achieved and maintained.

ECG Isolated Power Supplies

DC/DC converter circuits produce all the isolated power voltages required by the ECG Amplifier circuit.

The -2.0Vi and the 2Vi isolated reference voltages are generated from the -5Vi supply.

Note: When taking measurements always ensure that the isolated ground is used for reference.

MK 18-1 Main Board (cont.)

ECG Signal

The incoming ECG signals RA, LA, and C1 to C6 are low-pass filtered and applied to non-inverting operational-amplifiers giving a gain of 11. The signals are further band pass filtered (approximately 0.05 Hz to 470Hz) and amplified by 23 before being applied to the multiplexer.

The multiplexer sampling rate is 1000Hz.

Noise Damping

The right leg electrode to the patient is the signal ground reference signal. To assist in cancelling some patient noise and thus reducing incoming signal distortion, the incoming signal from the patient left leg electrode is phase shifted 180°. This phase shifted signal is then used by the signal ground reference to cancel (or reduce) patient induced noise.

RS-232 Interface

This is a standard RS-232 / V.24 interface connected to the MK 18-10 main board. The communications controller contains a USART and interface circuit which performs the parallel / serial and serial / parallel conversion for the transmission and reception of data and provide signal level compatibility with RS-232 standard.

External Modem

An external modem can be connected to the RS-232 output from the AT-102 and be used for transmitting memory contents over a telephone line.

Top Assembly

LCD Screen

The LCD power supply produces the high voltage for the LCD backlight and the contrast voltage. LCD data is stored in a video RAM and the LCD controller converts the data to the proper form for the LCD screen.

Alphanumerical Keyboard

The keyboard is a matrix style circuit which is periodically scanned by the processor via the keyboard interface circuit. It is an integral part of the top assembly and can not be individually replaced.

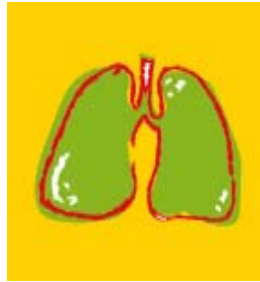

Section 3

Fault Finding

Introduction

The AT-102 is designed to be simple to use and simple to service: the service philosophy of the AT-102 is module and board replacement (no details are given in this book for board repair). The purpose of this chapter is to provide fault-finding procedures that will quickly and efficiently identify a fault to a specific module. Fault-finding procedures are designed so that test equipment is kept to a minimum.

The AT-102 contains the following modules:

- MK 18-1 Main Board including main and LCD power supplies
- LCD screen assembly
- Alphanumerical keyboard (integral part of the top assembly)
- Printer assembly
- Paper tray motor

An initial fault-finding table is provided detailing general fault indications. Use the procedures on the following pages to indicate a faulty area or module. In most cases the fault finding tables should indicate the most likely faulty area. When more than one module is stated, the first module given is the one most likely to contain the fault. Other modules given should be checked in the order given. When a module has been replaced specific test parameters and setting-up of the module may be applicable. The removal and replacement instructions for all replaceable modules, along with any setup or check procedures required, are given in Chapters 4 and 5.

If the initial fault-finding table does not indicate the area where the fault exists, re-check all the settings and parameters that have been entered. If these are correct, check the software.

General Check Procedures

The procedure detailed here is a general confidence check of the unit after an internal module or board has been replaced. It is not a full functional test (which can only be carried out with dedicated equipment in the factory) but is intended to provide a general confidence check in all the major AT-102 functional areas. The instructions given here are guides to the basic functions. If more operating information is required (general settings, comprehensive menu guides etc.) please refer to Chapter 1 in this publication or the AT-102 user guide.



Fault Finding Chart

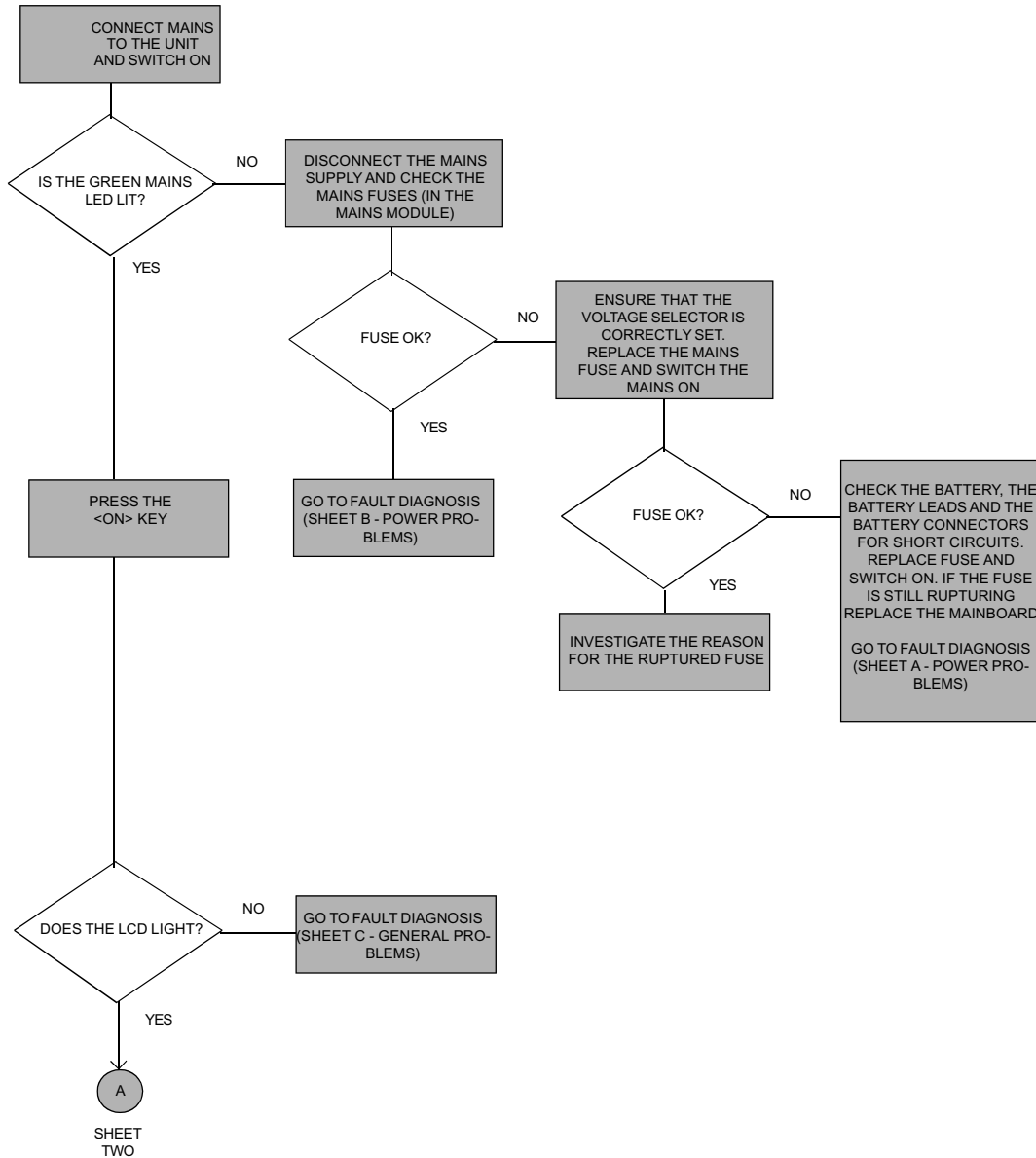

NOTE:

The removal and replacement instructions and the location of all boards, cable assemblies and connectors are given in Chapter 4.

AT-102 Initial Fault Diagnosis Chart (Sheet 1)

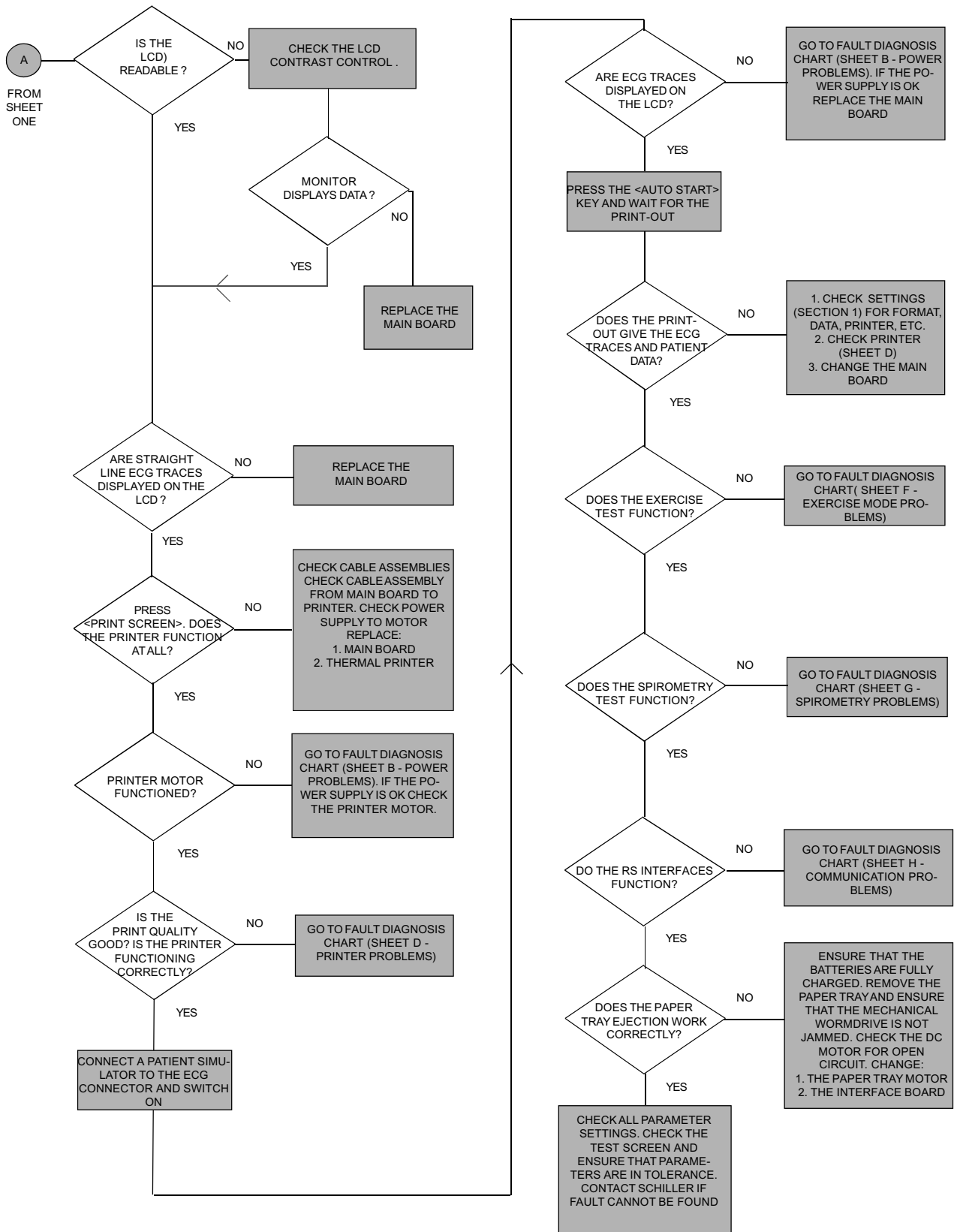

AT-102 Initial Fault Diagnosis Chart (Sheet 2)



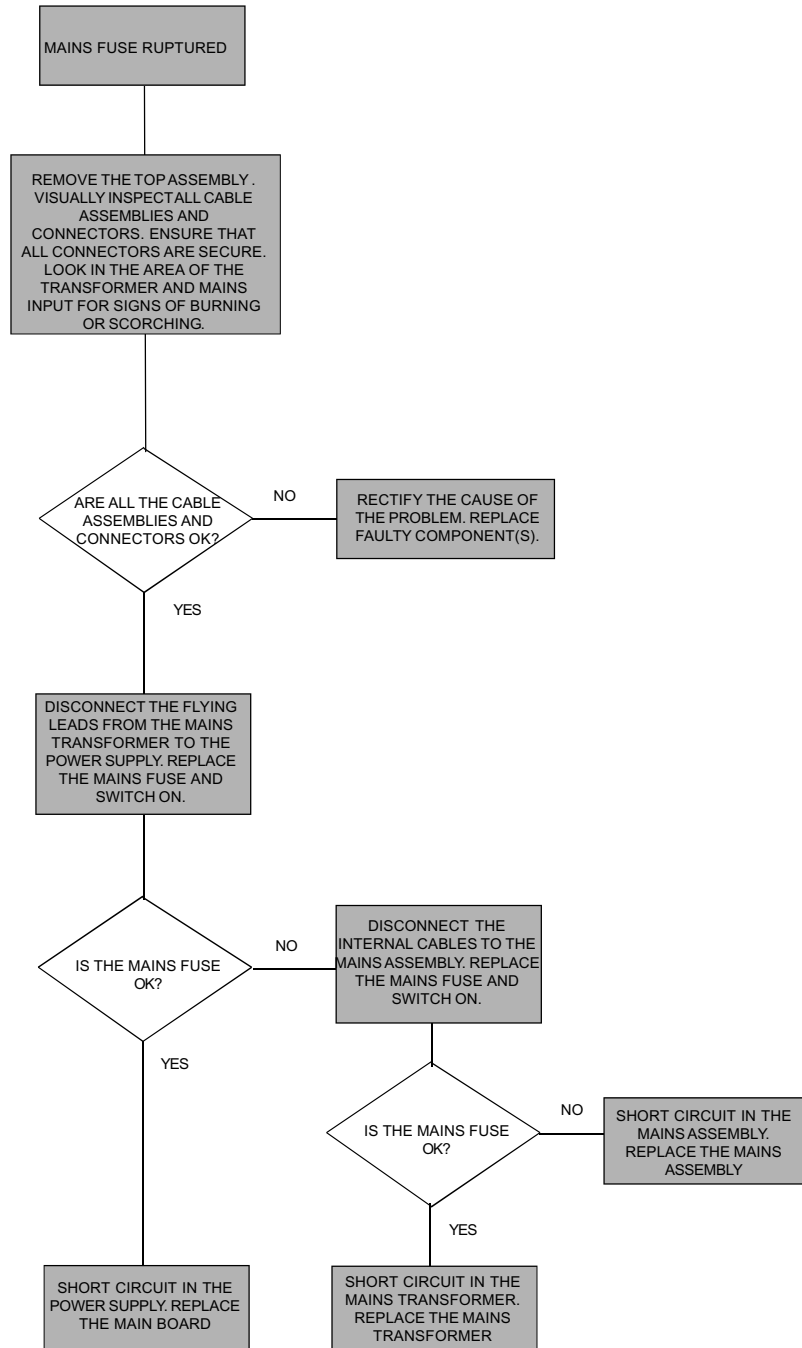

AT-102 Fault Diagnosis Chart (Sheet A - Power Problems)

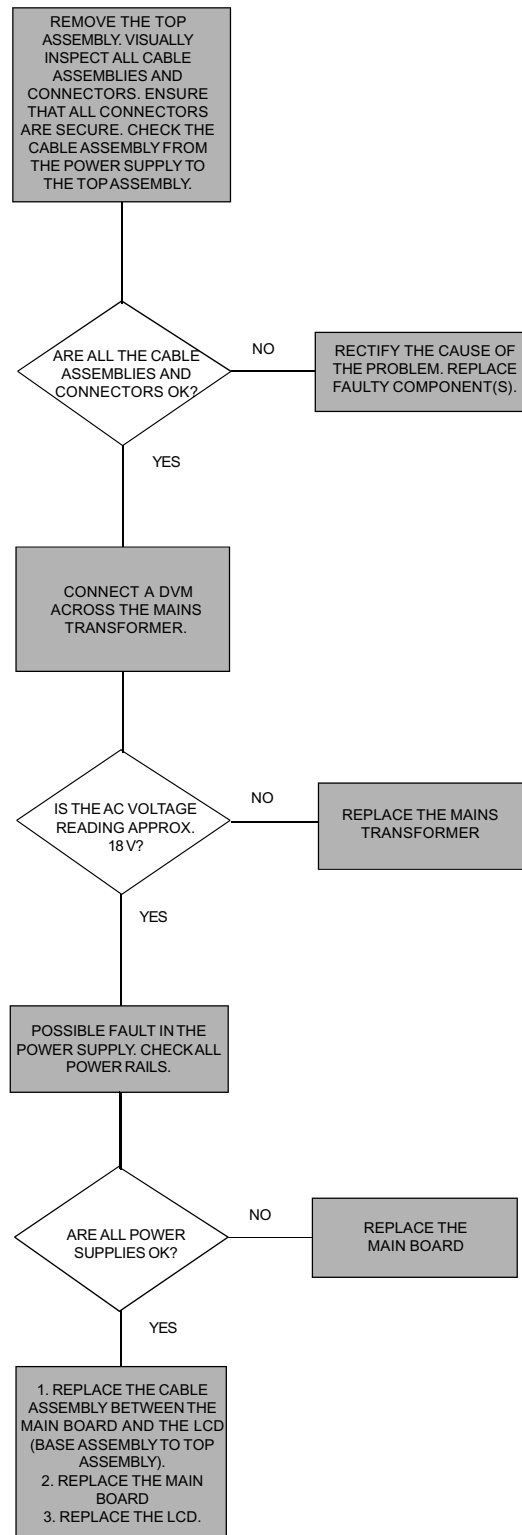

AT-102 Fault Diagnosis Chart (Sheet B - Power Problems)



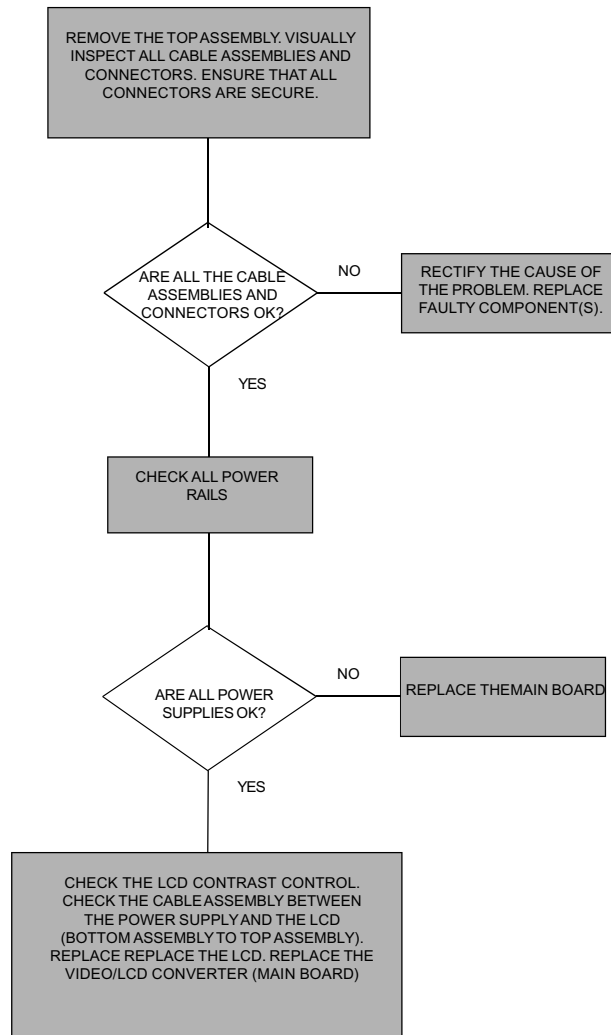

AT-102 Fault Diagnosis Chart (Sheet C - General Problems)

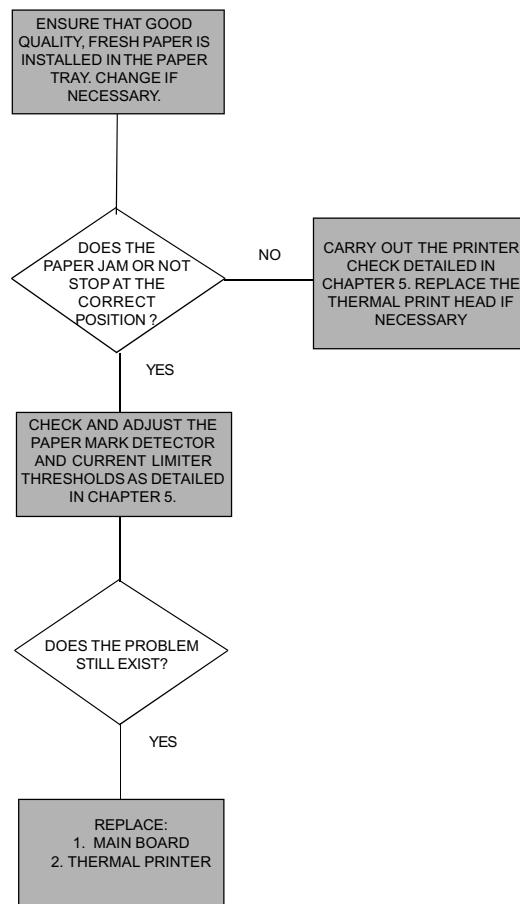

AT-102 Fault Diagnosis Chart (Sheet D - Printer Problems)

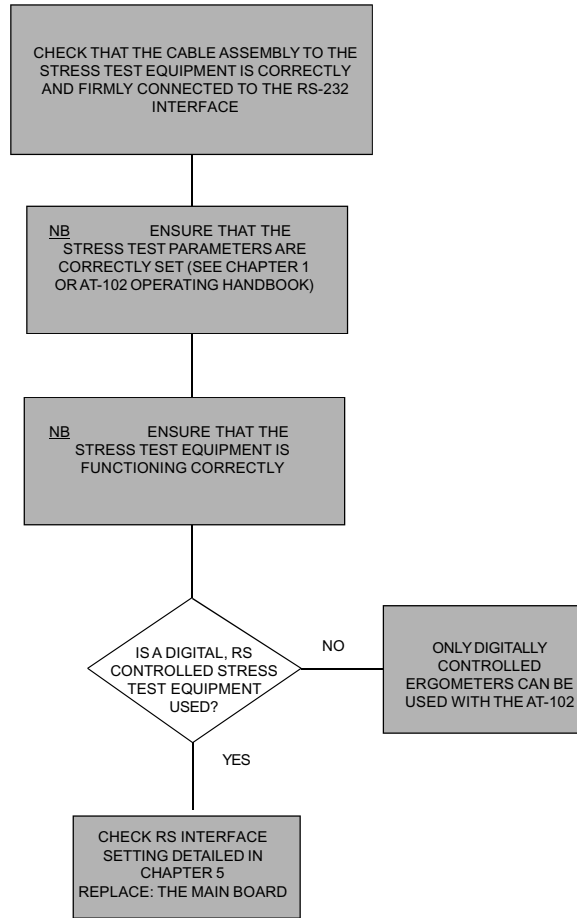

AT-102 Fault Diagnosis Chart (Sheet F - Exercise Mode Problems)



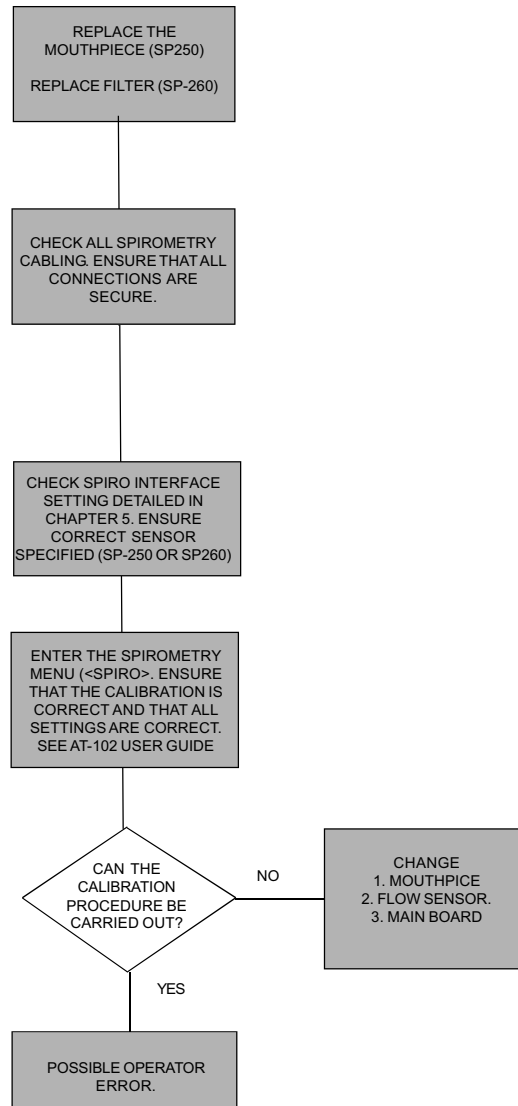

AT-102 Fault Diagnosis Chart (Sheet G - Spirometry Problems)

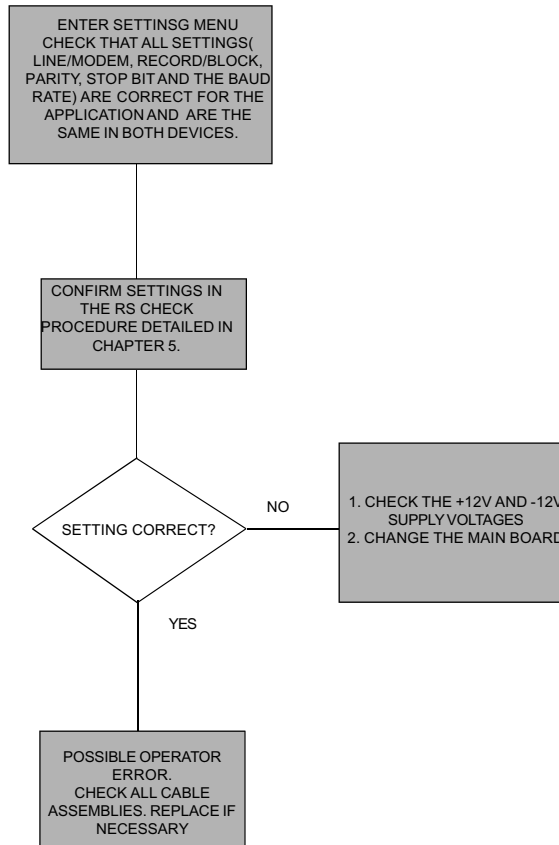

AT-102 Fault Diagnosis Chart (Sheet H - Communication (RS) Problems)

Functional Check

Test Procedure	Result	Corrective action if result not OK
Connect unit to mains supply.	Mains indicator (LED) is lit.	Check mains fuse on the back panel and replace if necessary. If problem remains, replace main board MK 18-1
Switch the unit on by pressing the ON key on the keyboard.	If no ECG simulator is connected, a short audible alarm is generated and the lead indications in the display are flashing.. LCD screen comes on and shows three ECG traces and a number of status indications. ECG traces are barely visible No traces visible on the LCD screen.	Ignore or connect ECG simulator Check power board, ECG and main board. Open the unit and check that the two wire connection from the power supply to the LCD assembly is properly connected (high-voltage backlight). If problem remains, replace LCD assembly. Check that the signal cable from the main board to the LCD assembly is properly connected. If problem remains, check LCD assembly, power, ECG and main board.
Connect an ECG simulator to the ECG connector on the side panel and switch ON.	Three ECG traces, heart rate, sensitivity, time scale and status of lead connections are shown on the screen.	If a lead alarm is flashing, check that the lead is properly connected
Press the MAN Start key.	Six leads are printed and are of good quality.	If not, reset to default settings and try again. Open the case and inspect all cable assemblies and connectors. Check printer alignment. Run printer test (see next page). Check / replace printer motor. Replace main board MK 18-1. Replace paper tray and complete printer assembly.
Press AUTO START and wait approximately 10 seconds for the printout to commence.	A preprogrammed printout is produced.	If not as programmed, check all settings. If problem remains, replace main board MK 18-1.
Switch the unit OFF and leave connected to the mains supply for 10 hours or more to charge the battery.		
Disconnect the mains and switch the unit ON.	Battery symbol is shown on the LCD screen.	
Run the unit on battery power for approximately an hour.	Unit fully operational. No degradation.	If not, check battery and replace if necessary.
Run the unit more than 4hours on battery power .	Battery symbol does not start flashing before 4 hours .	If the unit does run for 4 hours on battery power it indicates a weak battery. Replace as necessary.



Thermal Printer Check

To check the printer and to ensure that every pixel is operational, a built-in printer test is provided. Carry out the printer check from the ECG acquisition screen by pressing the FN key followed by the MANUAL PRINT softkey:

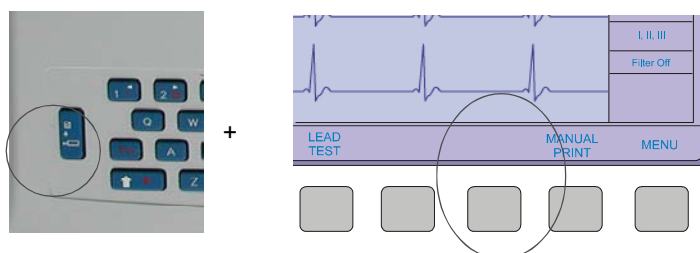

A `wavy line` test printout is given. Other test patterns are available - toggle the test patterns with the lead arrow keys.

Carefully examine the printout and ensure that all the lines are even and uninterrupted. Any faulty print-head pixels will be seen as a horizontal white line. Examine the printout for evenness of print

Faulty pixel shown as a horizontal line on the test printout. (exaggerated on this example for clarity)

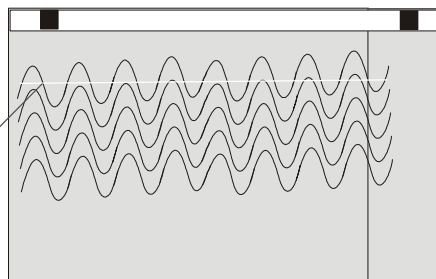

If a faulty pixel is detected the printer must be replaced. If the printout is uneven (for example darker at the top than at the bottom), it indicates that the printer alignment is not correct. If the printout is too faint or too dark, check the paper; old paper, paper that has been exposed to light for a long period, or poor quality paper can all adversely effect the print quality. A too light or too dark printout also indicates that the TPH temperature is incorrect. Change the Printer.



NOTE:

The 'shelf life' of the printer paper is not indefinite. Old paper, paper that has not been stored in a cool damp free environment, or paper that has been exposed to excessive heat can adversely effect the quality of the print.

Thermal Printer Check

Print Head Alignment and Print Head Tension

The print head tension (the pressure that the print head exerts on the printer paper) is achieved with two springs exerting pressure on the print head: the print head tension cannot be adjusted. Similarly print head alignment is fixed and cannot be adjusted. If the print head tension or print head alignment is not correct change the printer.

Thermal Printer Fault Diagnosis

Possible Printer Problem	Corrective Action
Paper jams or does not stop at correct position.	Clean paper mark detector with a 70% alcohol solution. Allow to dry completely. Ensure that good quality, fresh paper is installed. Change the PM detector / Change the Printer Motor / changes the complete printer
Printout uneven; Fading at top or bottom.	Check evenness of spring pressure of the printer to roller. Check roller for wear and symmetry. Clean print head (pixel array) with alcohol. Ensure that good quality, fresh paper is installed. Change the printer, change the main board.
Faulty pixel.	Clean print head (pixel array) with alcohol. Replace printer.
Printout too faint or too dark; General quality poor.	Clean print head (pixel array) with alcohol. Ensure that good quality fresh paper is installed. Change printer , change main board.



RS-232 Interface (and Spiro Check)

There are no specific tests that can be performed on the RS-232 interface. However the RS-232 (UART) settings can be checked to ensure correct protocol and speed. If a spiro sensor is connected to the RS-232 connector, the sensor type can be displayed to ensure that it is the correct type. The Comm test screen is entered for the settings screen:

(MENU) > SETUP > SYSTEM SETTING > TEST and INFO > COMM TEST

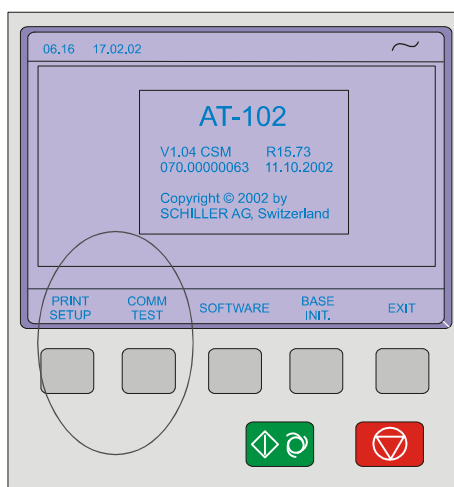

You are then prompted to select UART TEST and (only if a spiro sensor is connected to the RS-232 interface), SPIRO SENSOR.

When UART TEST is selected the current Baud rate, RTS and CTS settings are displayed.

When SPIRO SENSOR is selected the sensor type is displayed (SP-250 or SP-260), and the software version of the spirometry software.

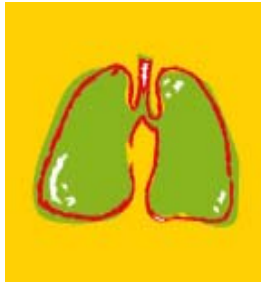

Section 4

Module Removal and Replacement

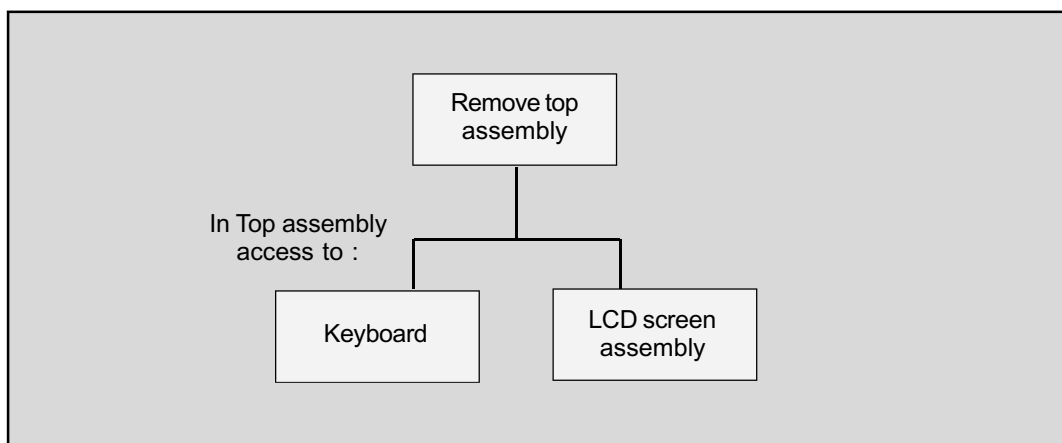
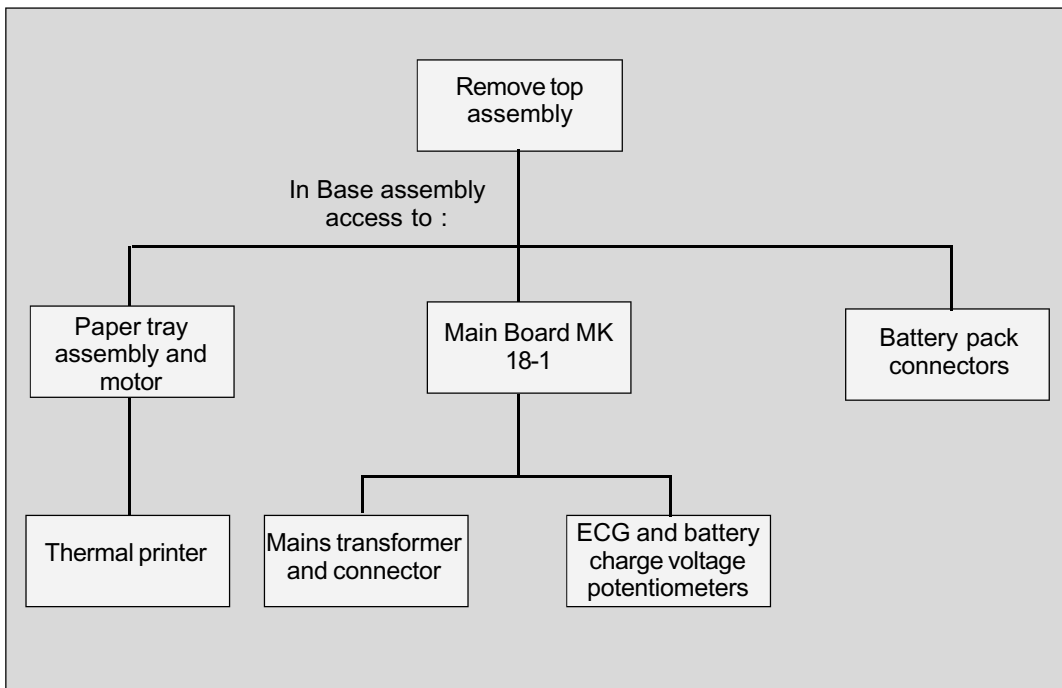

Introduction

This Chapter provides an overview of the procedures to remove and replace the modules that are spared at service level. The instructions given in this chapter are autonomous, with each module containing the following:

- The prerequisites that must be fulfilled before removing of the module
- Tools and equipment that are required to remove and replace the module and to carry out the functional checks and adjustments
- Removal Procedures
- Replacement Procedures
- Checks and Tests that must be carried out after replacement.

Any adjustments, jumper settings, special checks or functional procedures that are required during a procedure, are detailed in the relevant step.

In-text diagrams support the text where required and provide location details of connectors, test points and adjustment potentiometers.

Specific warnings and cautions are given where applicable. Warnings indicate potential danger that could cause personal injury. Cautions indicate areas that could cause damage to the equipment.

If a key operation or menu selection is required, the key sequence required is given in bold letters. The character (or character string) given is the actual character that is printed on the key. When a key sequence is provided it must be followed in the order given.

Safety Notices

WARNINGS



Before commencing any removal or replacement procedures ensure that the mains power supply is switched off and that the mains cable is removed.

Certain checks and adjustments can only be carried out with the top assembly removed and with mains connected. When carrying out these procedures beware that potentially lethal voltages are present.

CAUTIONS



The AT-102 contains static sensitive CMOS components; observe antistatic precautions:

When carrying out any maintenance procedures always place the unit on an earthed antistatic mat.

Personnel must be earthed when handling any boards or components

Always use an antistatic bag when transporting boards or components

The unit is susceptible to abrasion damage. To prevent scratching, always place the unit on a soft, non-abrasive cloth when carrying out maintenance procedures.

Take care not to place any strain on the connecting ribbon cable when removing the top assembly. Ensure that the cable assembly is not crimped or twisted and that the top assembly is not placed on the cable assembly.

Care must be taken when removing and replacing connectors. Never use force. Never strain the cable assemblies.

The procedural steps given for each module must be followed in the order given.



Physical Overview

The AT-102 unit is enclosed in a two part, medical standard, moulded plastic case.

The top part contains the keyboard and the LCD screen with the base section containing all the electronics of the unit, the RS-232 interface, the thermal printer, the paper tray, the battery and mains transformer.

The electronics of the unit are contained on a single double sided printed circuit board, the main board (MK 18-1). This board is secured on spacers moulded in the base section.

The battery is secured in position in a moulded recess accessed from the bottom of the units, and the mains transformer is secured on spacers above the printed circuit board.

The thermal printer is mounted on spacers moulded to the base and the paper tray motor mounted in a similar way.

Exploded View Lower Casing

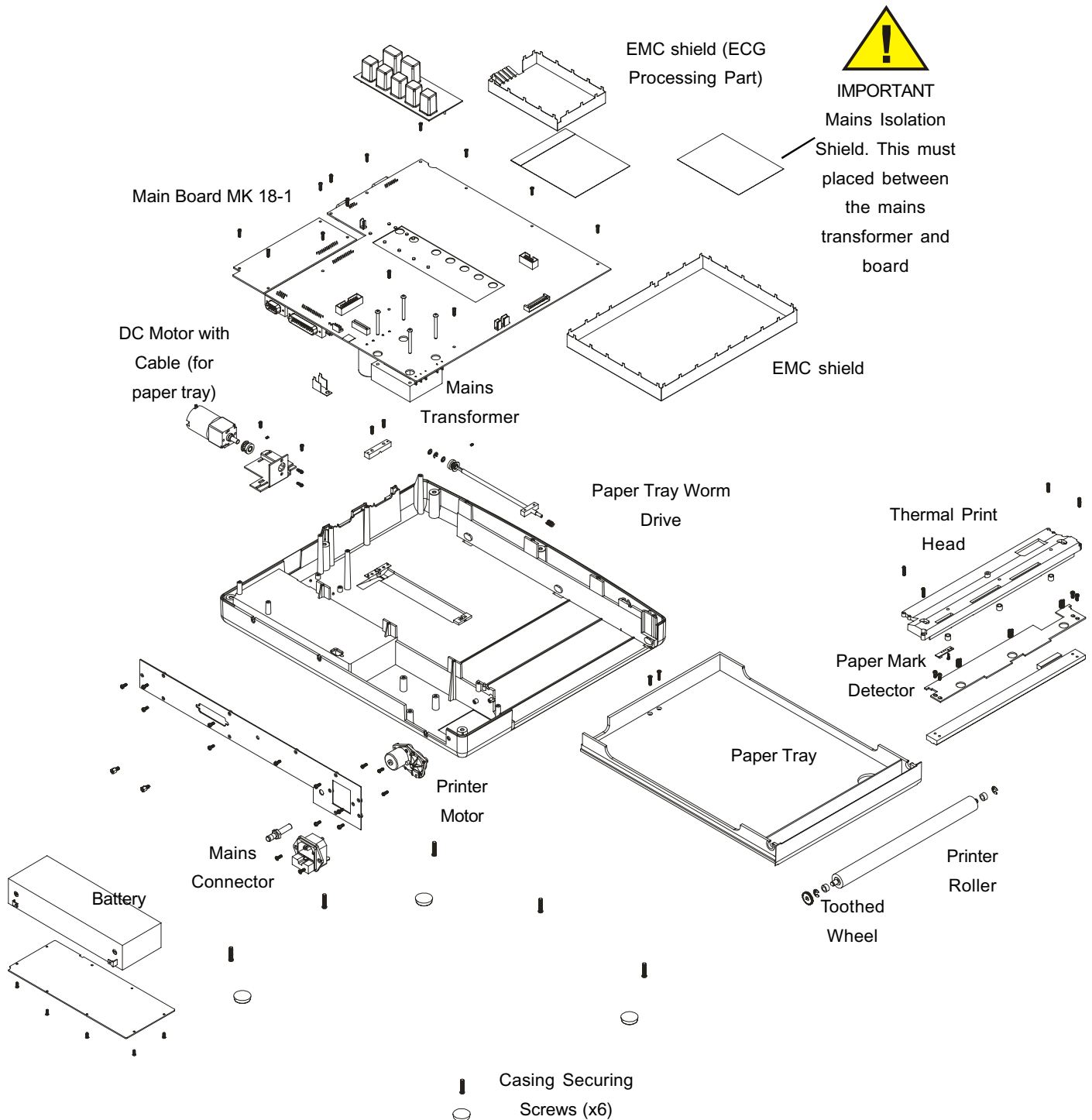

Exploded View Upper Casing

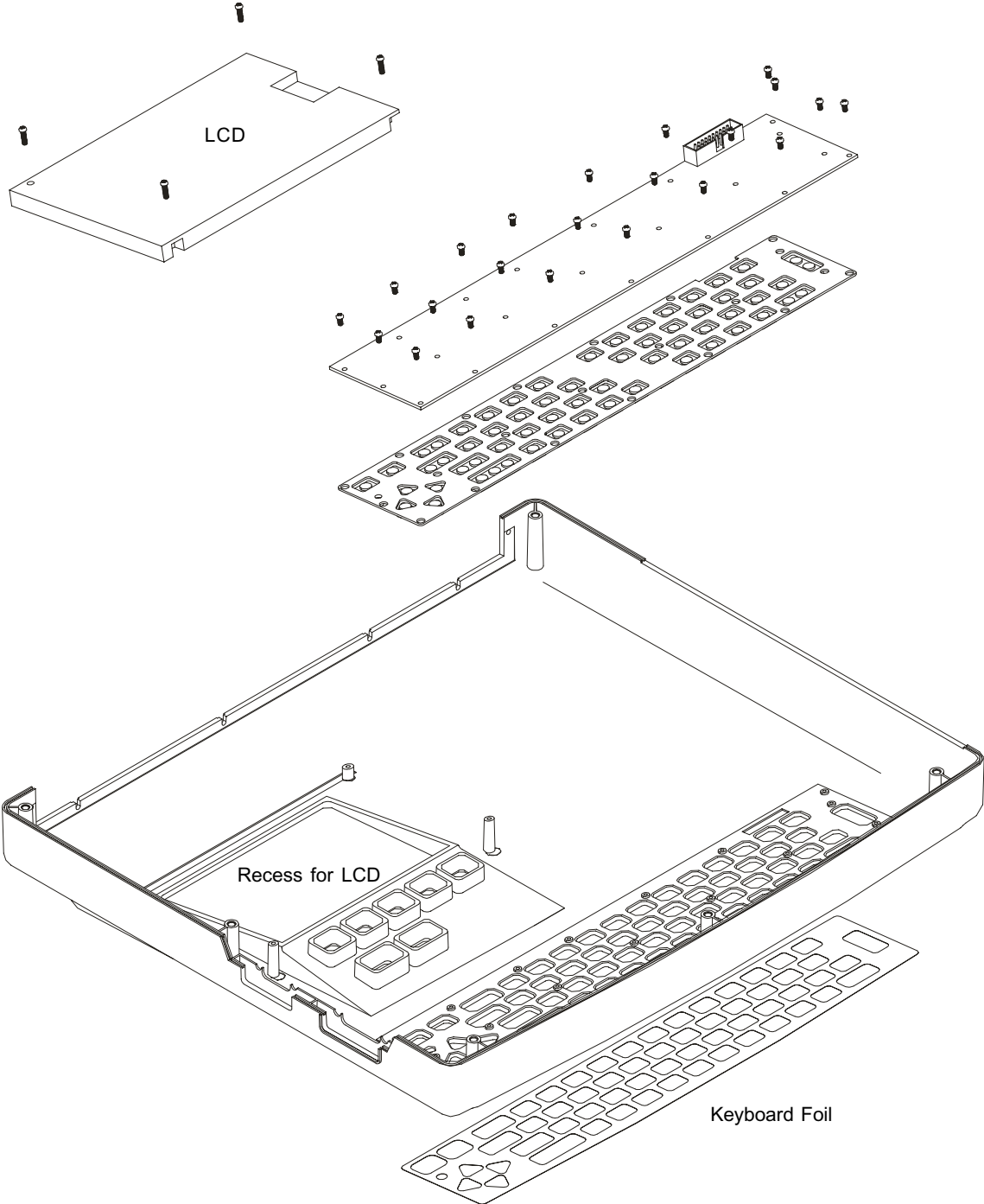

Prerequisites, Test Equipment, Tools, and Accessories

The following list gives the tools, test equipment and accessories required to carry out all removal and replacement procedures, functional tests, calibration procedures and adjustments that can be carried out on the AT-102. The test equipment given here is general. If specific recommendation for test equipment is required, please contact the SCHILLER service department.

- Digital Voltmeter
- Selection of cross-bladed, posi-drive and flat-bladed screwdrivers
- Cleaning agent such as Trichlorethylene
- Selection of spanners
- Flat ended pliers
- Double-sided tape
- ECG Patient Simulator, e.g. phantom 320.
- SCHILLER Patient Cable
- Low abrasion antistatic mat

General Prerequisites

- The unit must be placed on an antistatic mat and antistatic precautions observed when any maintenance is carried out on the AT-102. The room temperature should be between 18 and 28 degrees.
- The safety notices at the beginning of this section must be read and understood before carrying out any of the removal and replacement procedures detailed here.

Part Numbers

The part numbers for all replaceable items are given in Chapter 6.

Opening and Closing the Case

Top Assembly Removal

The Top Assembly is secured to the base assembly with seven recessed screws. Access to the screws is gained from the underside of the unit. To remove the Top Assembly, proceed as follows

**WARNING**

Ensure that the mains cable is removed.

1. Turn the unit up-side-down and rest on a soft antistatic cloth.
2. Unscrew and remove the six countersunk retaining screws and washers situated in the extreme corners and edges of the unit.
4. Grasping the top and bottom of the unit to ensure that the two assemblies cannot part, carefully return the unit to the standing position.
5. Gently lift the Top Assembly sufficiently to gain access to the interconnecting cables. Disconnect the cable assembly between the main board MK 18-1 and the keyboard and the ribbon and dual-wire cable assemblies between the power supply and the LCD screen board.
6. Gently lift the Top Assembly away from the Base Assembly and place on a soft cloth.



Opening and Closing the Case

Support the top casing in an 'upright' position to prevent straining the cable assemblies and connectors.



Opening and Closing the Case

Top Assembly Replacement

To replace the Top Assembly proceed as follows:

1. Check that all boards and components are firmly secured. Check for loose screws. Ensure that no screws or foreign bodies are loose in the bottom of the case.
2. Inspect all the internal cable assemblies and ensure that they are in good condition and that no visible damage can be seen. Ensure that no cable assemblies are strained, crushed or caught.
3. Ensure that all connectors are firmly home.
4. Position the Top Assembly in front of the Base Assembly and without straining the ribbon cable, plug in the interconnecting cable from the keyboard to the main board. Connect the ribbon and the dual-wire cable assemblies from the LCD board to the power supply part of the main board.

Note: It may be necessary to tilt the Top Assembly for the cable assemblies to reach.

5. Carefully position the Top Assembly on the Base Assembly.
6. Grasping the two assemblies to ensure that they cannot part, carefully turn the unit up-side-down and replace the seven securing screws and washers in the extreme corners and edges of the unit. Return the unit to the upright position.
7. Carry out the functional check procedure detailed in Chapter 3.

Main Board MK 18 - 1

Parts

Main board MK 18-1. Part number as detailed in Chapter 6.

Board Removal



WARNING:

The Warnings and Cautions at the beginning of the chapter must be observed.

Ensure that the mains cable is removed before commencing



CAUTION:

The main board contains static sensitive components; observe antistatic precautions.

1. Open the AT-102 casing as described previously, support the top assembly.
2. From the rear of the unit, unscrew the support securing screws.



Main Board MK 18 - 1

3. Carefully hinge the top assembly so that the top assemblies are apart as shown
4. Disconnect all connectors on the board including the live and the neutral bayonet connectors to the mains connector.
5. Unscrew the securing screws on the top of the board and remove the board.

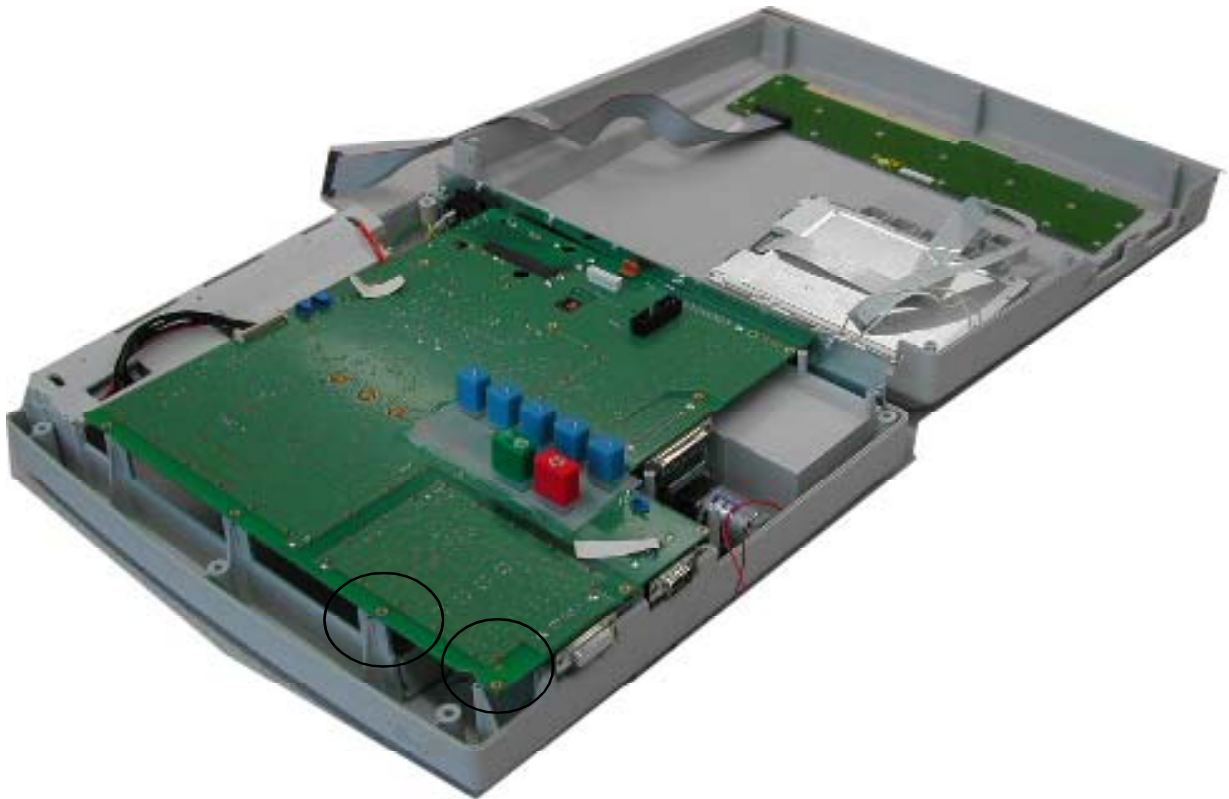

Main Board MK 18 - 1

Board Replacement

To replace the Main board MK 18-1 proceed as follows:

1. Position the board and secure at the 12 fixing points
2. Reconnect all connectors

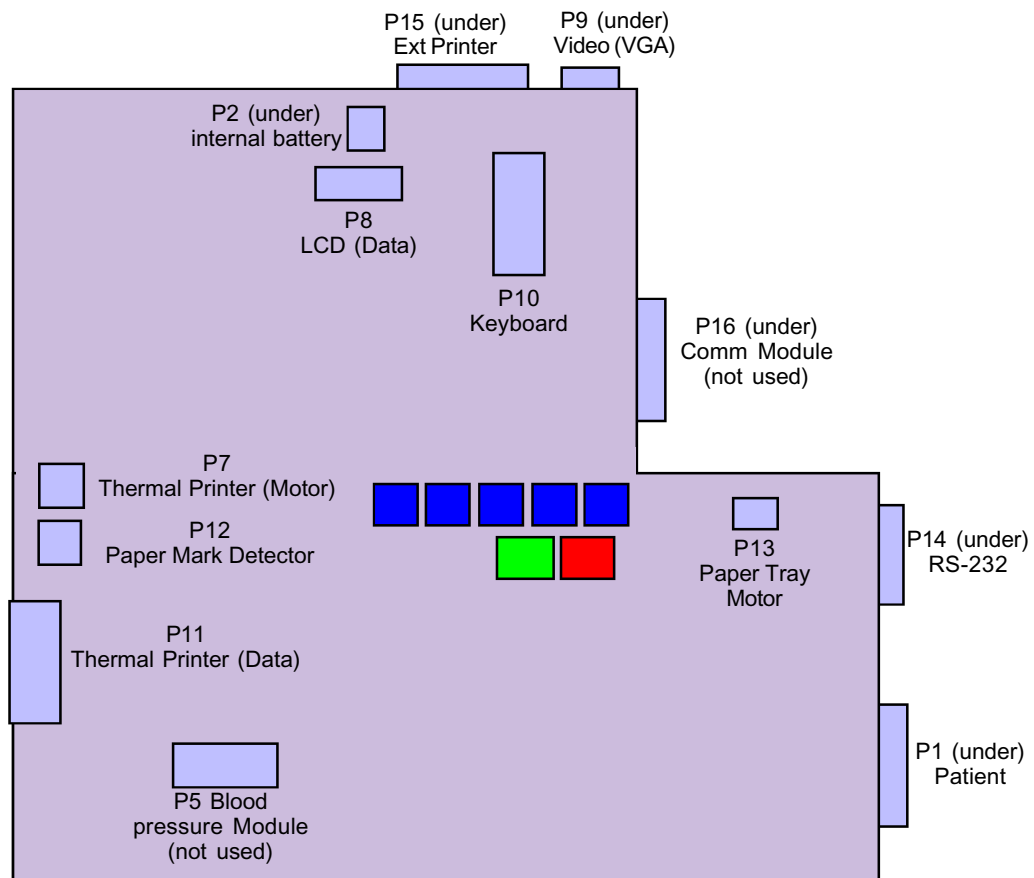

Printer Tray and Thermal printer

**CAUTION:**

The thermal printer contents is static sensitive; observe antistatic precautions.

The printer is tensioned with two springs under the retaining bar. Take great care when removing the four screws not to lose the springs.

Thermal Printer Removal

1. Remove the main board MK 18-1 as described previously.
2. Unscrew the four retaining screws securing the printer in position.
3. Gently remove the printer taking care to retain the two tensioning springs.

Thermal Printer Replacement.

To replace the thermal printer proceed as follows:

1. Position the printer in the paper tray/print assembly so that the printer mounting plate lips slot into the dedicated cutouts in the assembly;
2. Insert the two tensioning springs so that the springs are positioned over the outer two moulded spring supports and in the indent (hole) in the printer mounting plate
3. Position the printer retaining bar and secure the printer and printer retaining bar with the four retaining screws. Ensure that the cable assemblies from the printer to the PCB are not caught and are not strained.

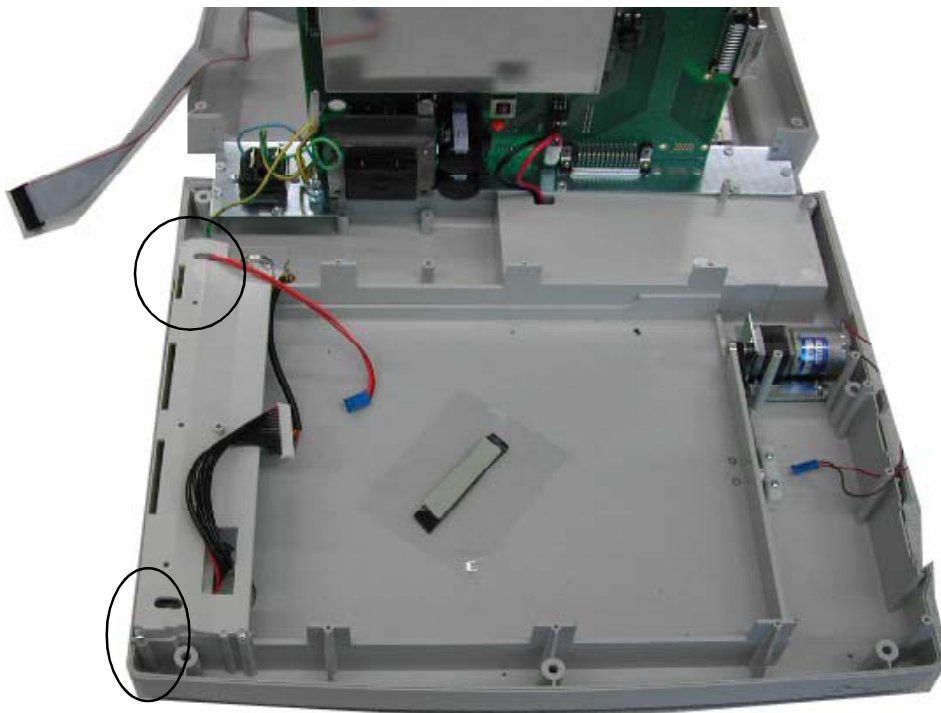

Battery Pack

Battery Pack Removal



WARNING:

The Warnings and Cautions at the beginning of the chapter must be observed.

Ensure that the mains cable is removed before commencing

To remove the Battery Pack proceed as follows:

1. Remove the top assembly as detailed previously.
2. Disconnect the two bayonet connectors for the Main board (P2).
3. Gently return the top assembly in position, and firmly holding both parts, turn the unit up-side-down.
4. Unscrew the battery compartment cover plate retaining screws and remove the battery.



Checks and Tests After Battery Replacement

Program all static settings which will have been lost when the battery was disconnected including date and time.



Keyboard

The keyboard comes as a complete assembly with the top casing. The part number of the keyboard is given in Chapter 6.

LCD screen board



WARNING:

The Warnings and Cautions at the beginning of the chapter must be observed.

Ensure that the mains cable is removed before commencing



CAUTION:

The main board contains static sensitive components; observe antistatic precautions.

LCD board Removal

1. Disassemble the top and bottom sections as described previously.
2. Disconnect the data connector and the LCD backlight power connector for the Main board
3. Unscrew the four retaining screws securing the LCD board in position and remove the board.



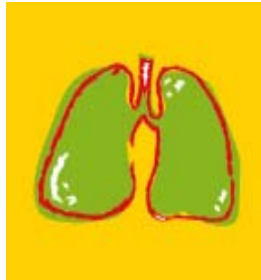

Section 5

Adjustments, System Upgrades and Software Updates

Introduction

This Chapter provides the procedures necessary to check and adjust all service settings. Every procedure is self-contained and details the tools required to carry out adjustments, and the test equipment necessary. Any adjustments, jumper settings, special checks or functional tests that are required on the module, or on associated modules or software, are also detailed.

In-text diagrams support the text where required and provide location details of connectors, test points and adjustment potentiometers.

Specific warnings and cautions are given in the text where applicable.

The part numbers for all replaceable modules are given in Chapter 6.

The AT-102 has the following adjustments:

- Battery Charge Voltage (VR3 on the main board MK 18-1)
- ECG Amplifier reference voltage and ramp slope (VR1 and VR2 on the main board MK18-1)

We recommend that the reference voltages are checked every year.

Safety Notices and Conditions



WARNINGS

Mains power is potentially lethal - disconnect the mains before disassembling the unit and remove the mains cable.

Setting the battery charge voltage requires that mains is connected during this procedure. Exercise extreme caution. Be aware at all times that mains voltage is present.

All other maintenance, calibration, checks, or adjustments must be carried out with battery power only



CAUTIONS

The AT-102 contains static sensitive cmos components; observe antistatic precautions. When carrying out any maintenance procedures always place the unit on an earthed antistatic mat. Personnel must be earthed when handling any boards or components. Always use an antistatic bag when transporting boards or components

Care must be taken when removing and replacing connectors. Never use force. Never strain the cable assemblies.

The procedural steps given for each module must be followed in the order given.

The outer surfaces of the AT-102 are susceptible to abrasion damage. To prevent scratching, always place on a soft, non-abrasive cloth.

Conditions

- The unit must be placed on an antistatic mat and antistatic precautions observed when any maintenance is carried out on the AT-102.
- The room temperature should be between 18 and 28 degrees.

Test Equipment

The following proprietary and dedicated test equipment is required to fault find and carry out all board checks and adjustments on the AT-102.

The list of proprietary equipment is not comprehensive. Recommendations of suitable proprietary test equipment can be obtained from the SCHILLER Service Department.

Proprietary Test Equipment/Tools

- ECG Simulator, e.g. Phantom 320
- Oscilloscope
- Digital Multimeter
- Standard tool kit with a selection of cross-bladed, flat-bladed and posi-drive screwdrivers, pliers and general tools
- SCHILLER, 10 lead patient cable Number 2.400070 (2. 400071 for USA)

Main Board MK 14-10 Adjustment Locations

Component Location MK18-1 (Component Side)

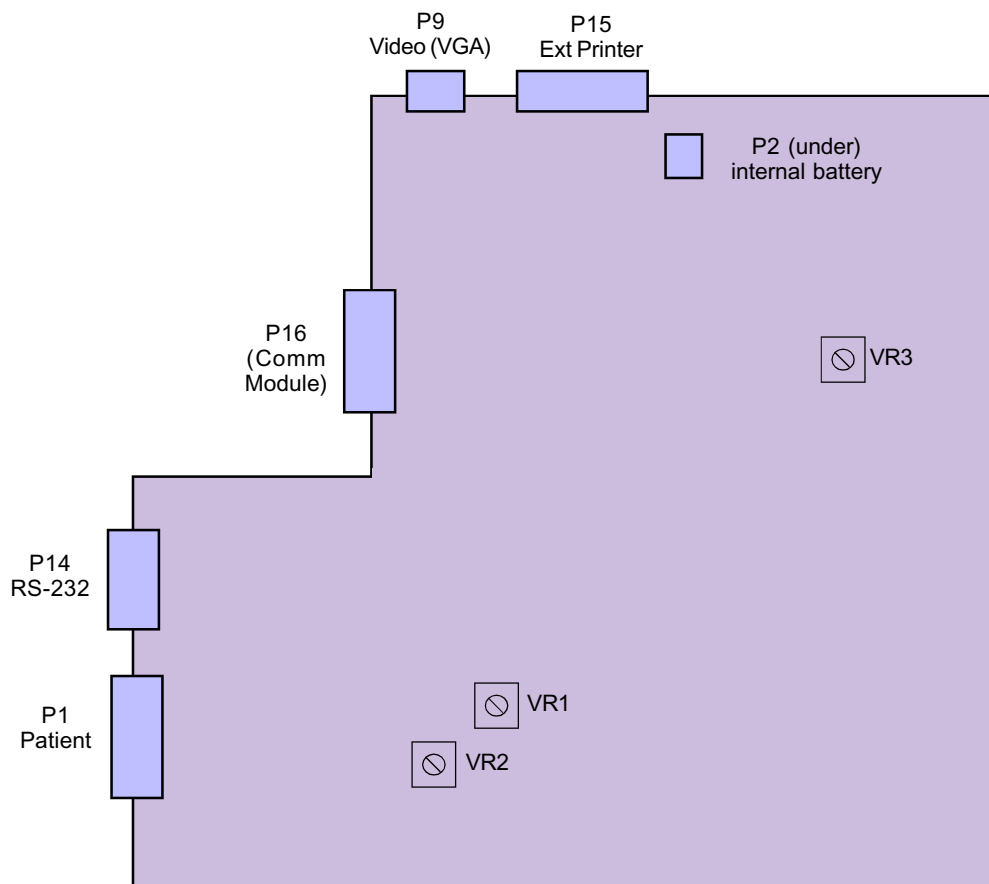

Battery Charge Voltage

Precautions and Requirements

The unit must be placed on an antistatic mat and antistatic precautions observed when any maintenance is carried out on the AT-102. The room temperature should be between 18 and 28 degrees.

Tools and Equipment

- Digital voltmeter
- Small flat bladed screwdriver
- Resistor 2.7kOhms, 250mW

Procedure

The battery charge voltage is nominally 13.5V. Adjust and check as follows:

1. Disassemble the unit as detailed in chapter 4.
2. Remove the Main board MK 18 - 1 from the assembly and remove the EMC shield from the board.
3. Replace the board in position.
4. Remove the two battery connectors (if not already removed) and connect a 2.7 kOhm 250mW resistor across the two battery connectors on the main board to simulate a discharged battery. Connect the digital multimeter across the resistor.
5. Connect the Mains supply.



WARNING

Exercise care - be aware that potentially lethal voltages are present

6. Adjust VR3 to obtain a charging voltage of 13.5V.
7. Disconnect the mains supply and reassemble the unit as detailed in Chapter 4.

Paper Mark Detector Check

This procedure is a check only. There are no presets that can be adjusted. If this check fails the main board MK 18-1 must be replaced.

Tools, Equipment and Material

- Digital voltmeter
- Small flat bladed screwdriver
- 70% alcohol solution and clean lint free cloth

Procedure

To check the paper-mark Schmitt trigger sensitivity proceed as follows:



WARNING

Mains power is potentially lethal - disconnect the mains before disassembling the unit and remove the mains cable.

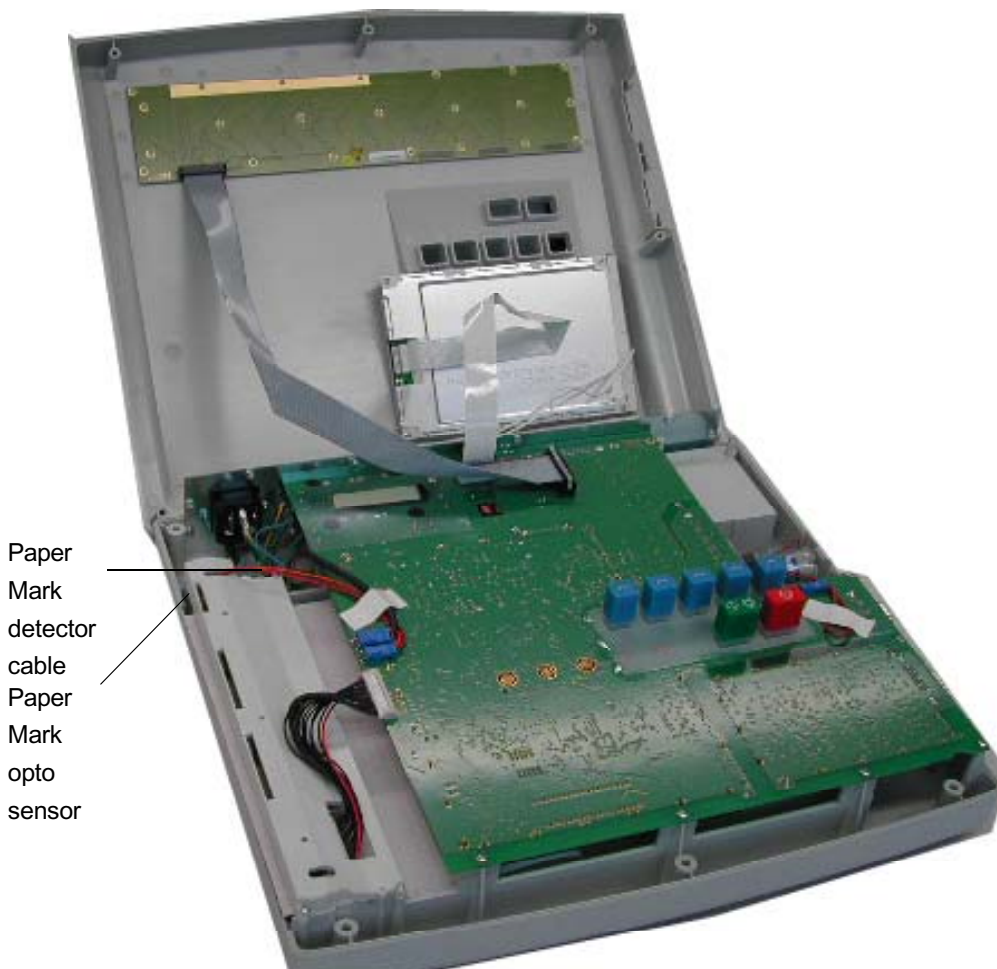

Paper Mark Detector Check

1. Disassemble the unit as detailed in Chapter 4.
2. Clean the photocell (situated on the opposite side to the dc motor) with a 70% alcohol solution. Allow to completely dry.
3. Reconnect the keyboard to the main board and place the top assembly on its side behind the Base assembly.
4. Switch the unit on and set the speed of the printer to the slowest setting of 5mm/s (5mm/s key).
5. Press the MAN START key to activate the printer. The paper is now moving at low speed (through the roller and paper mark detector).
6. Check the pulse amplitude at P12 pin 3. (Measure with AC setting, signal is noisy.)
 - no paper-mark (white paper) between -80mV and -200mV
 - paper mark (black paper) between -5mV and -30mV
7. Reassemble the unit as detailed in Chapter 4.

ECG Amplifier +2V, -2V and PWM Ramp Time Adjustment

The $\pm 2V$ voltage rails generated on the ECG Amplifier board are used as a reference by the measurement and PWM circuits.



NOTE

The $\pm 2V$ reference voltages, and the PWM ramp must both be adjusted at the same time.

Tools, Equipment and Material

- Digital voltmeter
- Small flat bladed screwdriver

Procedure



WARNING

Mains power is potentially lethal - disconnect the mains before disassembling the unit and remove the mains cable.

1. Disassemble the unit as detailed in Chapter 4.
2. Remove the Main board MK18-1 from the assembly and remove the EMC shield from the board
3. Replace the board in position
4. Reconnect the keyboard to the control board and place the top assembly on its side in front of the Base assembly .

ECG Amplifier Reference voltage

- Switch the unit on and measure the voltage difference between the +2V reference and the -2V reference on pins 1 and 7 of operational amplifier U79. Adjust trimmer VR1 to achieve a voltage difference of 4000 mV \pm 2mV.
- Reassemble the unit as detailed in Chapter 4. Re-check the voltage by again obtaining a service printout (see following).

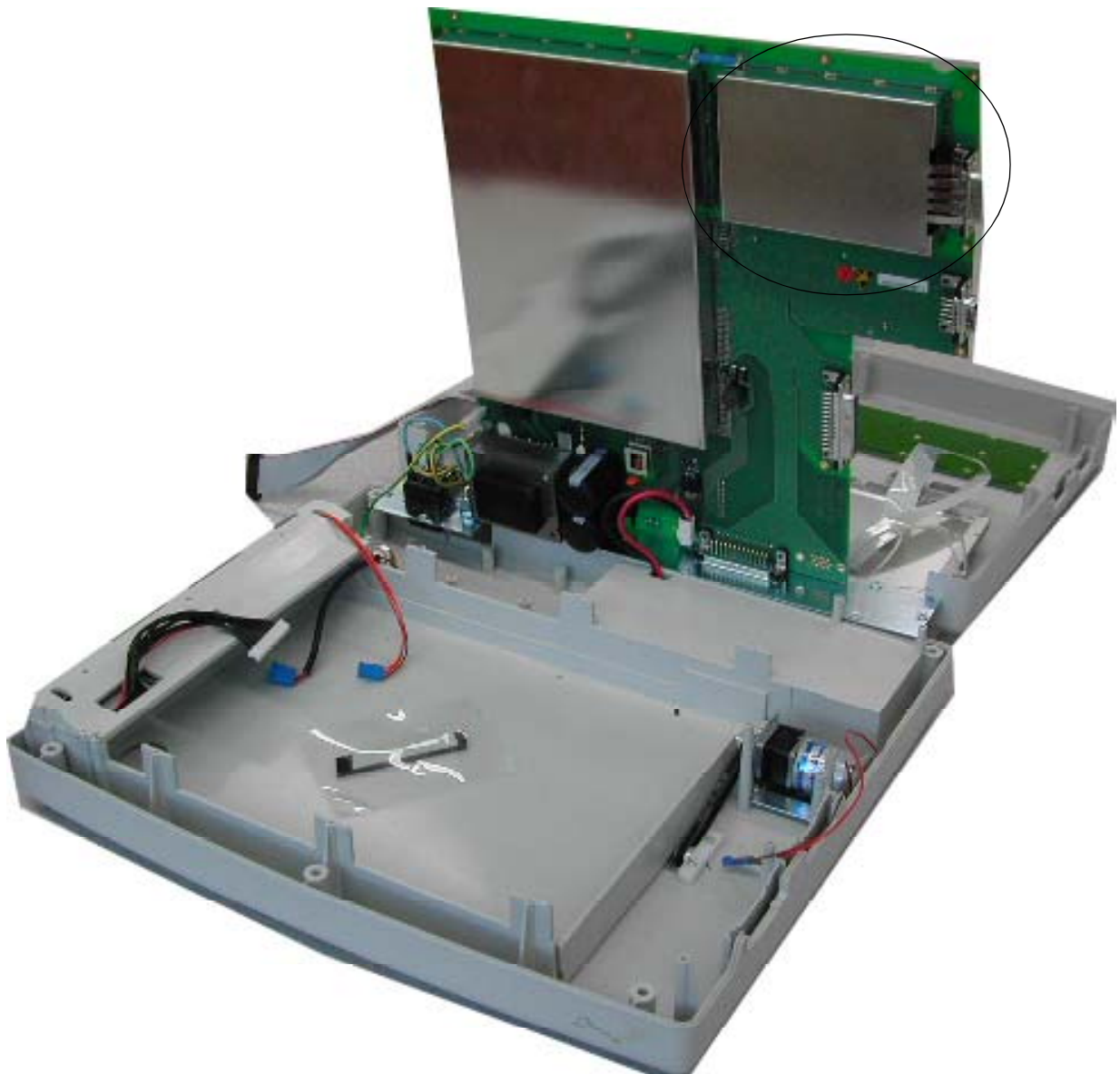

Service Screen

The service screen provides information of the patient cable and electrodes and gives the value of certain reference voltages and important internal offset values. These values are for information only. The service screen also gives variable settings and measurements that can be set by the service engineer; to carry out these adjustments some of the settings require additional test equipment. To display the service screen:

- Connect the patient cable
- Press alternative key (Fn) and from the resting acquisition screen press `LEAD TEST`.

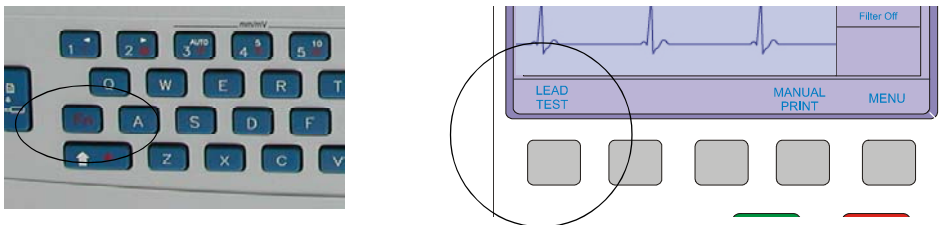

The following screen is displayed:

ECG AMPLIFIER:		U _{el} (mV)			
Uref+:	2001	R	2		
Uref-:	1996	L	1		
Udif:	3997	C1	2		
Uoff:	108	C2	2		
Calib:	998	C3	3		
		C4	1		
		C5	3		
		C6	1		
		TPH TEMP:		21°	
		EPROM:		6600	

To obtain a printout press P.

Service Screen (cont.)

ECG Reference Voltage	<p>This provides measurements and setting facilities for the reference voltage used for accurate measurement of ECG signals</p> <ul style="list-style-type: none"> ■ Uref+ This gives the value of the reference voltage used in the multiplexer circuit on the ECG Amplifier. The value of the reference voltage is 2000 mV \pm20 mV. ■ Uref- This is a negative reference voltage used on the ECG Amplifier board. The value of this voltage should be -2000 mV \pm20 mV. ■ Udif This is the sum of the two reference values above (Uref+ and Uref-). This value must be 4000 mV \pm 20 mV. ■ Uoff This is the value of offset voltage on the multiplexer circuit. This value should be in the range \pm 150mV ■ Calib This value is the Udif value divided by 4. The nominal value is 1000 \pm5 mV.
Electrode dc offset	<p>This gives the voltage drop in the patient cable and can indicate any faults in the patient cable or patient electrode. The value given is the dc voltage between the left leg electrode and all other electrodes. The measurements obtained will indicate any cable short circuits or open circuits. The measured voltage value will depend on where the electrodes are connected. The voltage readings that can be expected are as follows:</p> <ul style="list-style-type: none"> ■ With patient connected - \pm 100mV ■ With patient simulator connected - \pm 20 mV - this will depend on the patient simulator used and must be taken as a flexible measurement. ■ With all electrodes shorted together: - \pm 20 mV ■ No patient cable connected: -350 to -500mV
TPH TEMP	<p>This is the measured thermal print head temperature that the processor uses to correct print quality. When the printer has not been used for some time this should read ambient temperature \pm 5° but will rise quickly when the printer is used.</p>
EPROM	<p>This is the checksum for the EPROM. Its value varies from one unit to another and may change after a software upgrade.</p>

Upgrading the Unit / Updating the Software

Installing New Software Options (Upgrade)

Use the upgrade option to install any available software options (e.g. Exercise). To install new options in the AT-102, a code must be entered. This code must be obtained from SCHILLER. To install software option proceed as follows:

1. Enter the TEST and INFO screen:

SETUP > SYSTEM SETTINGS > TEST AND INFO

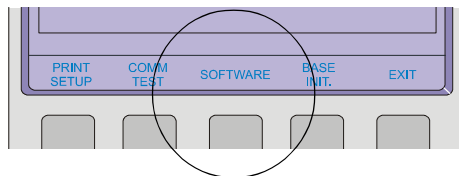

2. Select SOFTWARE. The following is displayed:

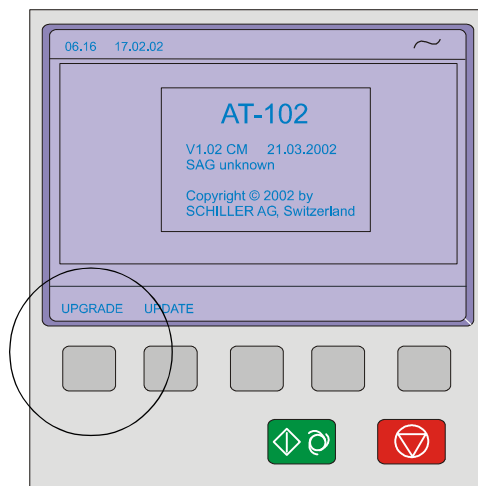

Upgrading the Unit / Updating the Software

3. Select UPGRADE. The following is displayed:

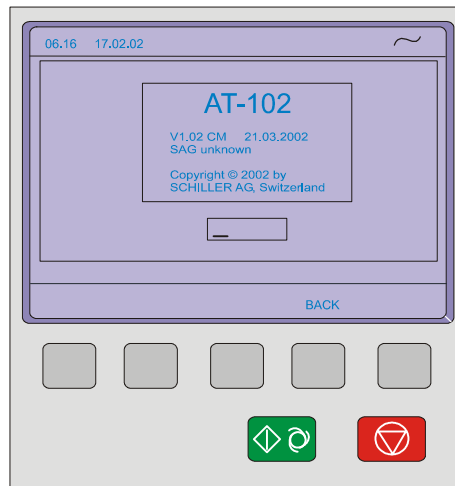

4. Enter the upgrade code

When the correct code is entered, acceptance of the code is indicated by a series of beeps. The option can be used immediately.



CAUTION

More than 10 attempts to enter the incorrect code blocks the unit

Upgrading the Unit / Updating the Software

Updating the System Software

The AT-102 software is updated using a PC program called SWUP. To update the software, the RS-232 connector on the side of the AT-102 is connected to a PC using a RS-232 to RS-232 cable assembly.

Prerequisites

- RS-232 cable assembly P/N 2.310 159.
- SWUP Programme for Windows™ (this can be downloaded from the SCHILLER Mailbox)

Procedure

1. Using the RS-232 cable assembly P/N 2.310 159, connect the AT-102 (RS-232 connector on the side of the unit) to any free COM port on your PC.
2. On the AT-102, enter the TEST and INFO screen
 SETUP > SYSTEM SETTINGS > TEST AND INFO

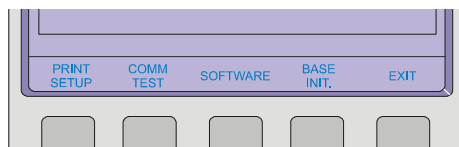

3. Select SOFTWARE. The following is displayed:

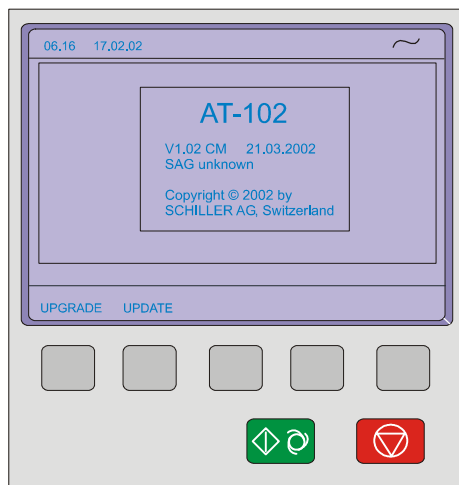

4. Select UPDATE

Upgrading the Unit / Updating the Software

5. Install the SWUP program on the PC (available from the SCHILLER Mailbox).
6. Follow the instructions given by the program.
7. Open the SWUP program through the SWUP icon on the desktop or via the Startup - Schiller-Menu. The following is displayed:

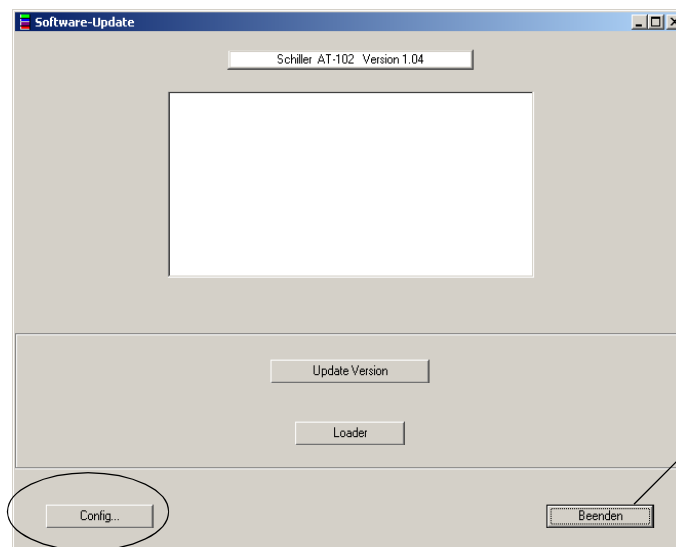

To exit the program without updating click the close icon

8. Click the config icon. The following screen is displayed:

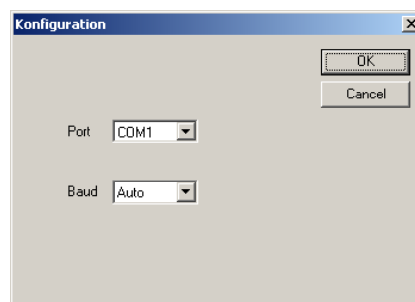

9. Select the applicable COM port (1 or 2). Set the Baudrate to `Auto` (or to the same Baud rate as set in the AT-102).
10. Click on `update version` to update the system software.
11. A series of beeps indicates that the software has been successfully updated. The updated software can be used immediately.

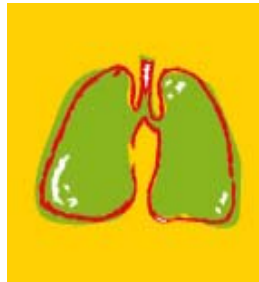

Section 6

Spare Parts

Ordering Information



WARNING

Always use SCHILLER replacement parts and disposables, or products approved by SCHILLER. Failure to do so may endanger life and invalidate the guarantee.



NOTE

Your local representative stocks all the disposables and accessories available for the AT-102.

Details of all local subsidiaries and agents are given on our web site:

www.schiller.ch

In case of difficulty or to obtain the address of your local dealer, please contact the head office. Our staff will be pleased to help process your order or to provide any details for all SCHILLER products.

The address for advice is:

SCHILLERAG
Sales Department (Order Processing)
Altgasse 68
6340 Baar
Switzerland
Phone Number: + (41) 41 766 42 42
Mail: sales@schiller.ch

If you need specific help from our service engineers, please contact the service department by mail (address given on our web site) or phone the number above.



Spare Parts

The parts listing for the AT-102 at the time of print was being revised. Please contact your local agent for parts listing.

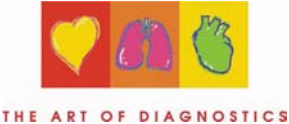

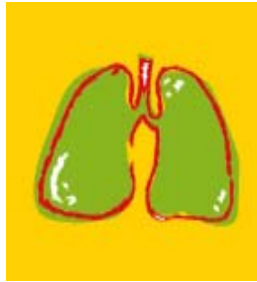

Section 7

Technical Data

The technical data is subject to change.

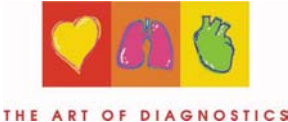

Technical Data

System:

Dimensions:	400 x 330 x 101 mm, approx. 5 kg
Built-in monitor:	120 x 90 mm effective display area, 320 x 240 dots resolution
On-screen status indicators:	Battery status
	Date, time
	Power source
Control panel and keyboard:	User-friendly, alphanumeric keyboard, LED indicator and monitor
Power supply requirements:	220 – 240 V (nominal), 50 / 60 Hz; 110 – 115 V (nominal), 50 / 60 Hz; stand-alone operation with built-in rechargeable battery; LED indicator for mains operation, integrated power supply unit
Battery capacity:	4 hours of normal use (approx. 300 automatic ECG print-outs or 100 spirometry records)
Power Consumption:	Max. 30VA
Line frequency filter:	Distortion-free suppression of superimposed 50 or 60 Hz sinusoidal interferences by means of adaptive digital filtering
Frequency range of digital recording system:	0 Hz – 150 Hz (IEC/AHA)
Chart paper:	Thermo-reactive, Z-folded, 210 mm wide (A4)
Printing process:	High-resolution thermal head printer, 8 dots/mm (amplitude axis), 40 dots/mm (time axis) @ 25 mm/s
Interfaces:	RS-232 interface to connect spirometry sensor; data transmission to PC (SEMA-200) and external modem connection; parallel port for external printer
Memory:	Storage for up to 40 ECG or Spirometry recordings
Environmental conditions:	Temperature, operating: 10° to 40°C
	Temperature, storage: -10° to 50°C
	Relative humidity: 25 to 95% (no condensation)
	Pressure during operation: 700 to 1060 hPa

Technical Data

Safety Standards:

Safety standard:	CF according IEC 60601-1 and IEC 601-2-25
Protection class:	I according to IEC 60601-1 (with internal battery), IIa according to EEC directive 93/42 (medical protection class)
Conformity:	CE according to 93/42/EEC

Technical Data for ECG:

Patient input circuit:	Fully floating and isolated, defibrillation-protected (only with original SCHILLER patient cable)
Monitor display:	3-channel display of the selected leads
	25, 50 mm/s
	5, 10, 20 mm/mV
	Filter status (on/off)
	Insufficient electrode contact
	Heart Frequency, HF
	mm/mv, mm/s
Leads:	12 simultaneous leads: Standard / Cabrera
Chart print-out speed:	5/10/25/50 mm/s (manual print)
Sensitivities:	5/10/20 mm/m, either automatically adjusted or manually selected
Automatic lead programs:	6/12-channel presentations of 12 simultaneously recorded standard leads on one or more A4 pages
	Numerous print-out formats can be selected
Data record:	Patient data (name, age, height, weight, BP), user ID
	Listing of all ECG recording conditions (date, time, filter)
	With optional interpretation (C) program: ECG measurements results (intervals, amplitudes, electrical axes), average complexes with optional measurement reference markings, guidance on interpreting adult and paediatric ECGs



Technical Data

Recording track:	6/12-channel presentation, optimal positioning on a width of 200 mm, automatic baseline adjustment
Filter:	Myogram filter (muscle tremor filter): 25 Hz or 35 Hz, can be switched on/off
ECG amplifier:	Simultaneous recording of all 9 active electrode signals (= 12 leads) Sampling frequency: 1000 Hz
Pacemaker detection:	$\geq \pm 2$ mV/ ≥ 0.1 ms

Technical Data for Spirometry (Option):

Measured values:	FVC: FVC, FEV _{0.5} , FEV _{1.0} , FEV _{3.0} , FEV _{0.5} /FVC, FEV _{1.0} /FVC, FEV _{3.0} /FVC, FEF _{0.2-1.2} , FEF _{25-75%} , FEF _{75-85%} , PEF, FEF _{25%} , FEF _{50%} , FEF _{75%} , FIVC, FIV _{1.0} , FIV _{1.0} /FVC, FIV _{1.0} /FVC, PIF, FIF _{50%} , FMFT, SVC: SVC, ERV, IRV, TV, MVV: MVV, RR, TV
Presentation possibilities (print-out and screen):	Flow/volume graph Volume/time graph Table of measured values Realtime flow curve
Data record:	Patient data (name, age, height, weight), user ID Registration conditions (date, time, date of last calibration) Flow/volume graph and/or volume/time graph Table of measured values with PREDICTED/ACTUAL/DIFFERENTIAL values Diagnosis guidance
Prediction equations:	Adults: ECCS, Austria, Crapo, Morris, Knudson, Knudson76, Polgar, Berglund, Finland, India, Composite Children: Quanjer & Tammeling, Austria, India, Knudson, Knudson76, Polgar Extrapolated predicted values Comparison of PRE/POST medication is possible
Standards Compliance:	ATS, OSHA, NIOSH



Technical Data

SPIROVIT SP-250 Pneumotach	Flow sensor for pulmonary function testing with disposable mouthpiece:
	Dimensions of SP-250: 118 x 36 x 28 mm, approx. 120 g;
	4.6 x 1.4 x 1.1 in., approx. 0.26 lbs
	Measuring method: Pneumotachometer
	Measuring accuracy: According ATS < 3%
	Flow impedance: < 0.2 mbar*s/l at 12 l/s
SPIROVIT SP-260	Pneumotach Flow sensor for pulmonary function testing with reusable mouthpiece:
	Dimensions of SP-260: 125 x 36 x 28 mm, approx. 160 g;
	4.9 x 1.4 x 1.1 in., approx. 0.34 lbs
	Measuring method, Measuring accuracy, Flow impedance same as SP-250
Delivered:	1 pneumotach sensor; choice of SP-250 disposable (P/N 2.100022) or SP-260 reusable sensor (P/N 2.100551)
	Accessories: 2 nose clips and either 1 pack of disposable plastic mouthpieces for SP-250 (P/N 2.100077) or 1 pack of disposable filters for SP-260 (P/N 2.100123)
	1 operating manual

Technical Data

Standard

CARDIOVIT AT-102 ECG with 12 simultaneous leads, pacemaker detection, automatic ECG measurement.

Accessories:	1 10-lead patient cable
	1 set of electrodes or disposable electrodes
	1 power cable
	1 pack chart paper
	Operating manual
Software options:	SEMA-200 PC software to save, validate and archive ECG and spirometry data on PC
Hardware options:	Equipment trolley
	Spirometry sensor SP-250 or SP-260
	Calibration syringe
	Vacuum electrode system VAC-100
	External printer

Configurations

The CARDIOVIT AT-102 is available in three versions:

Version M - Standard:	Unit with ECG recording, measurements, memory and printout capabilities.
Version C - Interpretation:	Standard unit with ECG Interpretation program
Version S - Stress:	C unit with ECG stress test program

Note The spirometry option, using the SP-250 sensor or SP-260 sensor, is available when the sensor is connected to the RS-232 interface.

Technical data subject to change without notice.

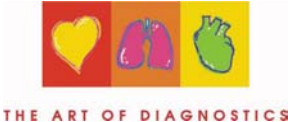



Annex A

Glossary

Introduction

The following list provides a glossary of the important signals and acronyms used in the circuit diagrams for the SCHILLER instruments. They will not all apply to the AT-102

Only abbreviations that are specific to SCHILLER equipment are included here. General electrical and electronic abbreviations are not included.

Acronyms

..OS	Offset signal (on the ECG amplifier).
A(1...n)	CPU Address Bus
ALBEEP(or BEEP)	Alarm beeper signal to the audio amplifier. The frequency of this signal is about 1000 Hz.
ANA1, ANA2	Analog input from the experimental inputs DC1 and DC2
AS	Address strobe
BATT	Signal to CPU indicating battery operation
BATTLC	Analog signal to the processor giving the charge condition of the battery.
BATTV	Battery voltage - analog signal from the power supply used by the processor to assess battery or mains operation.
BLOW	Battery less than 11.3 V. LCD flashes when this signal is active. When the battery drops to below approximately 9.4 V the unit is switched off. These values apply to equipment with 12 V battery. For other equipment the limits are different.
CHAD..	ECG signal multiplexer control signals (on the ECG amplifier).
CIF(0..16)	Communication interface. General control signals for the communications interface circuits.
CI(0..10)	RS interface control lines - input.
CO(0..10)	RS interface control lines - output.
CL1	19 kHz LCD latch pulse.
CL2	3.11 MHz LCD clock frequency.
CLK..	Clock signal. The number following the CLK indicates the frequency. For example CLK19 indicates a frequency of 19 MHz.
CS..	Chip select. The general format of the chip select signals is CS followed by some characters. The characters indicate the device to which the chip select signal appertains. For example CSRTC is the chip select signal for the real time clock and CSEEPROM is the select signal for the EPROM etc.
CTS	Clear to send. General signal used in data communication.
D(0..15)	Data bus.
DACWR	Digital / analog converter write.
DMUX	Data multiplexer.
DRAM	Dynamic RAM.
DRC(0..6)	Dynamic RAM control.

DS..	Data strobe.
DSP..	Digital signal processor (on program pack).
DTACK	Transfer data acknowledge. Bus signal to acknowledge transfer of data.
DTR	Outgoing serial data, turns modem ON.
ECGI	ECG in - serial ECG data to the CPU sent over the optical interface.
ECGMUX	The multiplexed ECG signal from the ECG amplifier.
ECGO	ECG out - serial ECG amplifier control data from the CPU sent over the optical interface.
EF	Empty flag.
EJCT	Eject (paper tray).
EKGRES	Reset signal to the ECG amplifier. This signal resets the ECG amplifier to recenter the ECG image on the LCD.
FIFOR	First in first out read
FLM	Control signal for frame synchronisation of the LCD.
FPIN	Input for floating point co-processor.
FWR	Flag read / write.
HREN	Output enable signal for thermal print head data (History enable).
HSYNC	Horizontal synchronisation (video / VGA output).
IPL0..2	Interrupt priority level (binary encoded).
IREG	Control signal from the current detector and limiter circuit on the power supply to regulate supply.
ISYS	Interrupt system (2 kHz).
KB..	Keyboard data in.
KBBEEP	Keyboard beep (to audio amplifier).
KBCLR	Keyboard clear.
KBCL1	Keyboard clock.
KBCL2	Keyboard clock.
KBIN	Keyboard data in - serial data from the keyboard to the CPU.
KBS..	Keyboard strobe.
KONV	Convert - this signal initiates the conversion of the incoming signal from the ECG amplifier.
LA	Left arm.
LEDB	Battery LED.



LEDMAINS	Signal indicating mains connected to operate LED indicator on the keyboard.
LCA	Liquid crystal address - enable.
LCD KONT	LCD contrast - sets the -18 V voltage level (from which the LCD backlight power is generated) and thus the contrast of the screen.
LD1,2,3,4	Lower LCD data.
LDS	Lower data strobe.
LOE	Lower output enable.
LP	Line synchronisation.
LSRAM	Lower output enable - control signal for static RAM.
LWE	Lower write enable.
M	LCD control signal derived from FLM.
MCLK	Motor clock - speed control for the printer motor.
MOD	Control signal from the battery charging circuit.
MOFF	Motor off.
MON	Motor ON - printer motor enable signal.
NWTZ	Mains supply.
NMI	Non-maskable interrupt activated by the reset button.
OFF	Off signal from the OFF key to switch off the power supply.
PDS	Control signal derived from FLM (unity waveform 1/2 FLM frequency).
PM	Paper mark signal.
PMARK	Paper mark detection signal.
PMPON	Pacemaker detection pulse.
PMNEG	Pacemaker negative - indicates the trailing edge of a pacemaker pulse.
PMPOS	Pacemaker positive - indicates the leading edge of a pacemaker pulse.
QTRRG	QRS trigger - output signal.
RA	Right arm.
RAS	Row address strobe.
RES _p	Error reset signal to inactivate the LCD.
RTS	Ready to send - outgoing serial data, handshake with CTS.
RXD	Receive data - incoming serial data.
R / W	Read / Write
RES	Reset.
RESLCD/	Resets / darkens the LCD.



SC(0..8)	System control bus - CPU control signals
SCINV	Screen inversion.
SO	Serial output from the CPU to the ECG amplifier via opto isolators.
SP..	Spirometry control and data signals.
SRAM	Static RAM memory.
STRB1/2	Timing signals for printer control.
SYSEN	System enable - active when the Program Pack is inserted. The CPU will not work if this signal is not active.
TGATE	Gate pulse for programmable timer. This signal sets the TPDUR signal.
TM	Thermal printer temperature - dc voltage from the print head, pulse width modulation of signal TPTH.
TPC	Thermal printer clock. This is not a continuous clock signal but is active when loading a line of printer data (into shift registers).
TPCLK	Thermal printer clock.
TPD	Thermal printer data - serial data for the printer.
TPDUR	Thermal printer duration - duration of the strobe pulse dependant on the ambient temperature of the print head and the resistance of the print head.
TPCSEL	Thermal printer controller select - control of thermal printer FIFO (input memory buffer).
TPL	Thermal printer latch - print strobe control and data latch signal.
TPRES	Thermal printer reset - FIFO reset for thermal printer controller.
TPS 0 & 1	Thermal printer strobe.
TPTH	Thermal printer temperature - dc voltage from the print head to ADC, approximately 3.7 V at room temperature.
TS	Temperature sense (from battery).
TXD	Outgoing serial data.
uPOFF	Off control signal. Logic 1 keeps the unit switched on, logic 0 switches the unit off. Note that the unit is initially switched on directly from the ON key on the keyboard.
U1,2,3,4	Upper LCD data.
+UB	Battery voltage.
UCAS	Upper column address strobe (for dynamic RAM).
UD1, UD2	Upper data strobe - used for generating UOE and UWE.
UDS	Upper data strobe - used on the Schiller gate array.
UOE, USRAM	Upper output enable - for static RAM.
+UP	Voltage rectified from the mains input and regulated to approximately +15 V.



UWE	Upper write enable.
+U	Unregulated dc supply from mains (approximately 30V).
+UBU	Back-up voltage for the real time clock and static RAM.
+UD	Unswitched regulated dc voltage used as power source for the switched supply +US. The voltage is 13.5 V when mains is connected, or battery voltage when mains is not connected. When mains is connected, this supply charges the battery.
-ULCD	Contrast voltage to LCD.
+US	Input voltage for all PSUs on the power supply board from the rectified mains or from the battery.
VCC	+5 V
VMA	Valid memory address.
VPA	Valid peripheral address.
VSYNC	Vertical synchronisation - (video / VGA output).
WP0 and WP1	ECG in - the serial multiplexed ECG serial data to the CPU sent over the optical interface, from the ECG amplifier.
XD0..XD3	Pixel information.
XSCL	Shift clock for XDn.
YD	Frame synchronisation.
YDIS/	LCD off.
ZEROSSET	Baseline reset (on the ECG amplifier) from the processor.

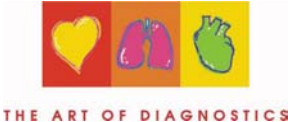

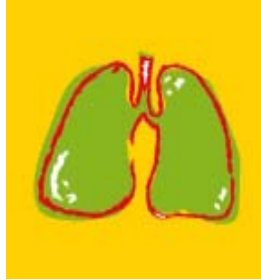

Annex B

AT-102 Circuit Diagrams and Engineering Drawings

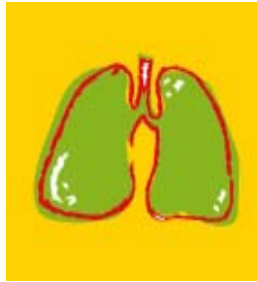

Index

Index

Symbols

+2V, -2V and PWM Ramp Time Adjustment 5.10

A

Article Number ii
 Associated Documents ii
 Auto-Centering 1.18
 Average Cycles 1.14

B

Back Panel 1.5
 Baseline filter 1.15
 Battery Care xi
 Battery Charge Voltage 5.7
 Battery Pack 4.16
 Baudrate 1.28
 Bicycle Protocols 1.24
 Blood Pressure Entry 1.21
 Board Removal 4.12
 Board Replacement 4.13
 Bruce 1.24

C

Cabrera 1.18
 Calib 5.13
 Changing a Mains Fuse 1.7
 Check Procedures 3.2
 Communications Test 1.32
 Component Location ECG Amplifier 5.11
 Configurations 7.7
 Contents iv
 Customer Services
 Sales Department 6.2

D

Date and Time 1.26
 Default Settings 1.33
 Default Test Protocol 1.22
 Defining / Editing Exercise Protocols 1.23
 Disposal Instructions xi

E

ECG Amplifier Adjustments 5.10
 ECG Amplifier Reference Voltage 5.11
 ECG Isolated Power Supplies 2.5
 ECG Printout 1.13
 ECG Recording Screens 1.3
 ECG Signal 2.6
 Electrode DC Offset 5.13
 ERGO Device 1.21
 Exploded View Base 4.6
 Exploded View Paper Feed 4.7
 External Connections - Back Panel 1.5
 External Modem 2.6

F

Factory programmed Protocols 1.24
 Features 1.2
 Function icons 1.3

G

General Settings 1.21
 Getting Started 1.1

I

Initiating Functions or Tasks 1.3
 Installing New Software Options 5.14
 Installing New Software Options (Upgrade)
 5.14
 Intended Use iii
 Interpretation 1.14
 Interpretation Settings 1.17

K

Keyboard 2.7, 4.17
 Keypad 1.8

L

Language 1.27
 LCD 2.7
 LCD Display 1.4, 1.10
 Lead group settings 1.19
 Lead Sequence 1.18
 Left Posterior 1.19

M

Main Components of the AT-102 1.4
 Mains filter 1.16
 Markings 1.14
 Measurements, Markings and Interpretation
 1.14
 MK 14-10 Adjustment Locations 5.6
 Mode 1.28
 Motor Speed 2.5
 Myogram filter 1.16

N

Nehb 1.19
 Noise Damping 2.6

O

Obtaining a printout of all current settings
 1.30
 Opening the Case 4.8, 4.10
 Operating Philosophy 1.3
 Ordering Information 6.2

P

Paper Mark 2.5
 Paper Mark Detector Adjustment 5.8, 5.9
 Patient Cable Resistance 5.13
 Phone No 1.28
 Physical Overview 4.5
 Physicians's Responsibility iii
 Posterior 1.19
 Potential Equalisation 1.7
 Power Indicator symbol 1.6
 Power On Reset 2.5
 Power Supply 1.6
 Precordials 1.19
 Print Head Alignment and Print Head
 Tension 3.14
 Printer 4.15
 Printer Timing 2.5
 Printout of all current settings 1.30
 Program Memory 2.4
 Proprietary Test Equipment/tools 5.5
 PWM Ramp Time Adjustment 5.10

R

Recycling xi
 Reference +2V, -2V Adjustment 5.10
 Removal and replacement 4.15
 Rhythm Lead Group 1.19
 Rhythm Leads 1.14
 Right Precordials 1.19
 RS-232 Interface 3.15
 RS-232 Test 3.14

S

Safety Notices xii, xiii, xiv
Safety Standards 7.4
SCHILLER SSF 1.16
Selecting the ERGO Device 1.21
Sequential 1.18
Service Printout 5.12, 5.13
Signals 1.18
Simultaneous 1.18
Smoothing Filter 1.16
software 5.14, 5.15, 5.16, 5.17
Spare Parts 6.3
Spiro Sensor Check 3.15
Spiro sensor type 3.15
Spirometry 7.5
ST Amplitude Lead 1.22
Stage Printout Format 1.22
Standard 7.7
Stepper Motor Controller 2.5
Stress Settings 1.20
Switching On and Off 1.6
System 7.3
System Option 5.14, 5.15, 5.16, 5.17
System Settings 1.25

T

Terms of Warranty x
Test Equipment 5.5
Thermal Print Head Controller 2.4
Tools 4.8
Top Assembly Removal 4.9
Top Assembly Replacement 4.11
Treadmill Protocols 1.24

U

Udif 5.13
Unit Defaults 1.34
Uoff 5.13
Upgrade 1.32, 5.14
Upgrading the System Options and Updating software
5.14, 5.15
Uref + 5.13
Uref - 5.13
User Identification (User ID) 1.26

W

Warranty x

